

THE NEW VALUE FRONTIER



ULTRA HIGH VACUUM
COMPONENTS

ULTRA HIGH VACUUM COMPONENTS

超高真空用部品

KYOCERA Corporation

『人類社会の進歩発展に貢献する』

“Contribute to The Advancement of Society and Humankind”

これは京セラ株式会社の経営理念の一節です
社会のインフラ整備や未来に向けた科学研究の一翼を担うことで
次の世代の生活を豊かにする
それが私たち京セラ株式会社の使命です

This is a passage from the management philosophy of Kyocera Corporation.
Kyocera's mission is to enrich the lives of the next generation by contributing
to infrastructure development and undertaking scientific research for the future society.

半導体製造装置 Semiconductor Processing Equipment



各種端子部品
Feedthrough

自動車 Automotive



EV リレー部品
EV Relay Part

LNG 関連



電力・エネルギー Energy

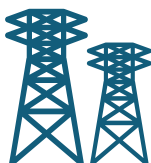

航空・宇宙
Aerospace



研究機関
R & D



加速器用部品
Accelerator part

通信

Communication



電極付きインダクタコア
Inductor Cores with Electrode

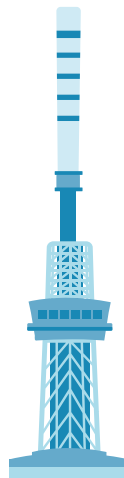

お客様のご要求に沿った設計提案

Design Proposals to Meet Customers' Requirements

京セラが長年培ったセラミック製造、及びメタライズ技術のノウハウをベースに、お客様のご要求に対して最適な形状提案を致します。

Kyocera proposes optimum shapes of fine ceramic components to meet customers' requirements based on the ceramic manufacturing and metallization technologies that Kyocera has cultivated over many years.

セラミック製造技術

Manufacturing Technologies of Ceramic Components



創業以来一貫して自社生産で培ったノウハウにより、高品質なファインセラミック部品を提供します。

Kyocera provides high-quality fine ceramic components by utilizing the expertise we have accumulated through consistent in-house manufacturing since our establishment.

メタライズ技術

Metallization Technologies



長年培ったメタライズ技術を用いて、お客様のご使用環境に最適な手法で製造を行います。

Kyocera manufactures components that are best suited to the customer's usage environment using the metallization technologies we have developed over many years.

シミュレーション技術

Simulation Technologies



セラミック/メタライズ共に自社生産で、双方の条件を考慮した正確なシミュレーションを実現します。

In-house manufacturing of both fine ceramics and metallized components enables high-precision simulation that takes the conditions of both into consideration.

商品開発力

Product Development Capability



一貫生産ラインにより、課題に対して様々な切り口からアプローチが可能で新しい製造手法を検討します。

Taking advantage of our integrated production line, Kyocera will investigate a novel manufacturing method that enables different approaches from various points of view.



目次

1. Were you aware of the vacuum components? _____	6
~真空部品のこと、ご存知でしょうか?~	
2. Ceramic to Metal Assemblies _____	8
~長年培った京セラのメタライズ技術~	
3. Ordering Process _____	9
~製品の選定について~	
4. For Product Selection _____	10
~製品選定ガイド~	
丸形多ピン端子 Circular Multi-Pin Feedthroughs _____	12
Multi-Pin Connectors (Bayonet Lock Series)	
Multi-Pin Connectors (MS Series)	
同軸端子 Coaxial Connectors _____	18
BNC Type	
SHV Type	
MHV Type	
N Type	
SMA Type	
LM Type	
Feedthroughs _____	27
Isolators _____	34
Sapphire Windows _____	36
Introducing New Technology _____	38
5. Custom-designed Ceramic Chambers _____	43
6. Technical Information _____	52
セラミックスの特性表 Characteristics of Ceramics	
形状と加工精度 Precision Shaping and Matching	
Material Comparison Chart	
接合金属の特性表（代表例） Characteristics of Metal (Example)	
メタライズ技術 各種素材と加工 Metallization Technologies and Materials	
セラミックスと金属の基本的な接合構造 Basic Design of Ceramic-to-Metal Bonding	

Were you aware of the vacuum components?

真空部品のこと、ご存知でしょうか？

京セラの超高真空用メタライズ部品は、真空・液体・ガス環境など、大気中とは異なる環境で製造や実験を行うために使用される密閉容器（チャンバー）に使用されています。

一般的に、導通部と絶縁部を気密封止した構造となっており、京セラでは絶縁部にファインセラミックスを使用しております。この真空部品は、溶接によってフランジへ取り付けられ、Oリングやガスケットなどを使用して気密性を確保し、チャンバーへ取り付けられます。

Kyocera's ultra-high vacuum metallized components are utilized in sealed containers (chambers) for manufacturing and scientific experimentation in different environments, such as vacuum, liquid, and gas environments.

These components generally have a structure that is hermetically sealed between the conductive portion and the insulating portion. Kyocera uses fine ceramics for the insulation section. The vacuum component is welded to the flange and installed in a chamber using an O ring and a gasket to secure hermeticity.



種類	概要
気密端子 Vacuum Feedthroughs	ハーメチックシール、フィードスルー、電流導入端子などとも呼ばれ、密閉容器において信号や電流・電圧の出し入れを行う目的で容器に取り付けられます。 Also called hermetic seals, feedthroughs, or vacuum current feedthroughs. Attached to sealed containers for taking in and putting out signals or current/voltage.
絶縁部品 Electrical Insulator Parts	配管の接続部の絶縁などを目的に使用されます。 Used for electrical insulation of piping connections
サファイア窓 Sapphire Windows	チャンバー内部の様子を観察するための単結晶サファイアを利用した覗き窓です。 Optical windows featuring single-crystal sapphire to observe the inside of the chamber.

■一般的な気密端子の部品構成イメージ Image of component constitution for conventional vacuum feedthrough

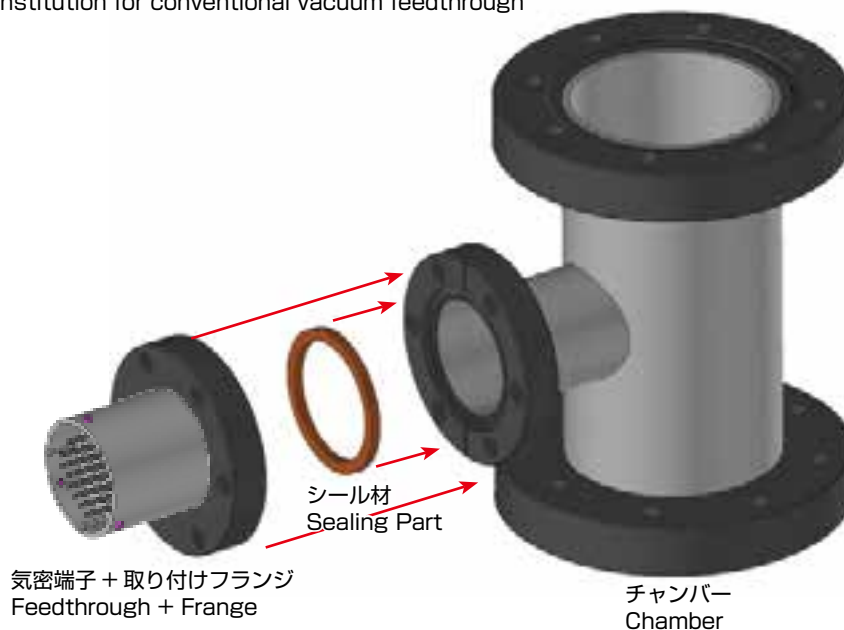

非金属（セラミックス）と金属の接合方法

Ceramic-to-Metal Bonding Technology

京セラでは、超高真空用部品を製造する際、セラミック部材と金属部材をメタライズ+ロウ付けで接合しています。では、なぜロウ付け接合なのでしょう。

一般的にセラミックスと金属を接合する場合、樹脂による接合、ガラスによる接合、そしてロウ付けによる接合の大きく3種類に分けられます。樹脂接合では、樹脂からアウトガスが発生し真空度が上がらなくなるため、高い真空環境下では使用ができません。ガラス接合では、アウトガスの発生は抑制できますが、高真空下では接合強度が不足してしまい、気密性が確保できません。これに対し、メタライズ+ロウ付けによる接合は、超高真空という過酷な環境でも高い気密性と接合強度を示します。

京セラの超高真空用部品は、長年培ったファインセラミックスの製造技術と、メタライズ技術を融合させ、厳格な基準の下で検査を行い、宇宙開発など特に信頼性が重要な分野でも採用されています。

Kyocera utilizes metallization and brazing for bonding ceramic and metallic members to manufacture ultra-high vacuum components. What are the advantages of brazing?

Generally, ceramic-to-metal bonding technology is divided into the following types: bonding with resin, bonding with glass, and bonding with brazing. Components using resin bonding cannot be used in ultra-high vacuum environments because the vacuum will not increase due to outgas from the resin. Glass bonding cannot maintain hermeticity due to insufficient bonding strength in ultra-high vacuum environments, although it can prevent outgas generation. In contrast, bonding by metallization and brazing enables high hermeticity and bonding strength, even in the harsh environment of an ultra-high vacuum.

By integrating the fine ceramic manufacturing and metallization technologies that have been cultivated for many years, Kyocera's ultra-high vacuum components are produced and inspected in accordance with strict standards. Applications are expanding into areas requiring precise reliability, such as space development.

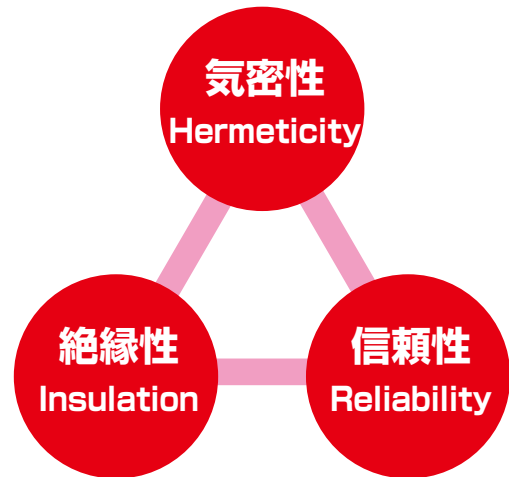

■ 接合方法による適用範囲（概念図）

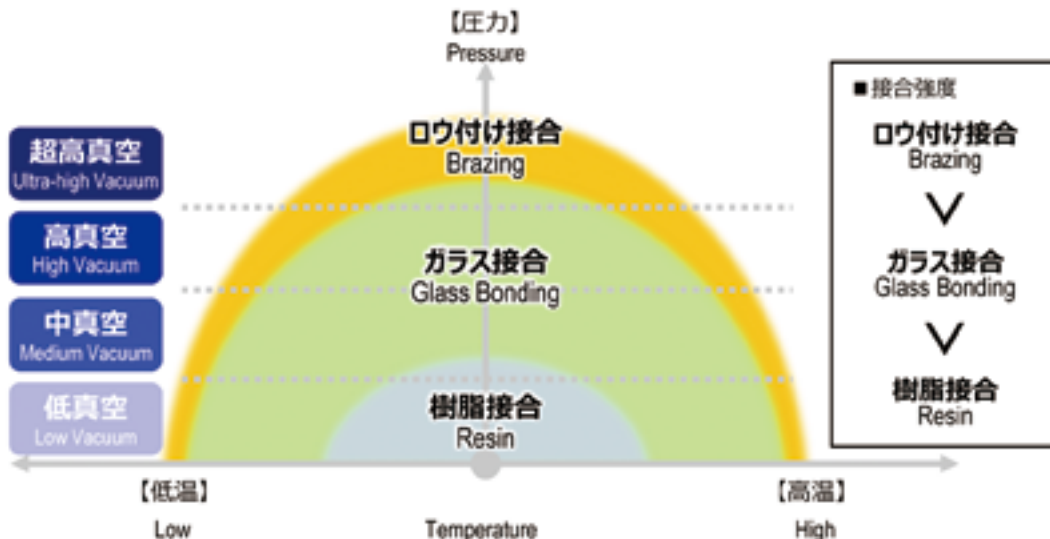

Ceramic to Metal Assemblies

長年培った京セラのメタライズ技術

強度と気密性を併せ持つメタライズ + ロウ付け接合

Strength and Hermeticity Achieved by Metallization and Brazing Bonding Technology

セラミック部品と金属部品を強固に、そして高気密に接合するためには、ロウ付けで接合することが必要です。しかし、一般にセラミックスと金属は接合性が悪く、直接接合しても強度が低く使用できません。そこで、セラミックス表面に金属層を形成し(メタライズ)、それを下地にしてロウ付け接合を行うことで、強固で高い気密性を持ったセラミックスと金属の接合を実現しています。

Bonding with brazing is essential for achieving ceramic-to-metal bonding with high strength and high hermeticity. However, the direct bonding of ceramics with metal generally results in poor characteristics leading to an inability to use the resulting products due to the weak strength. We therefore utilize metallization and brazing bonding technology, which first creates a metal layer on the ceramic surface (metallization) and then brazes the metal on the metallic surface to achieve ceramic-to-metal bonding with high strength and hermeticity.

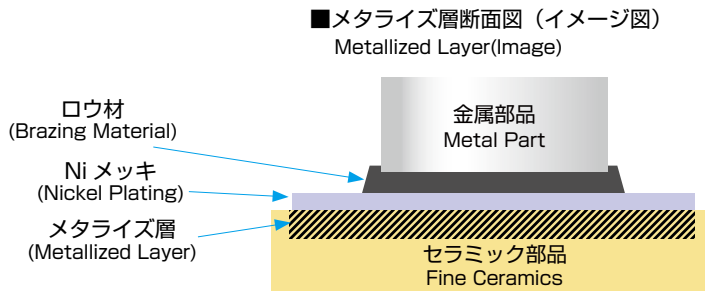

■メタライズ部品の製造工程 Metallization Process

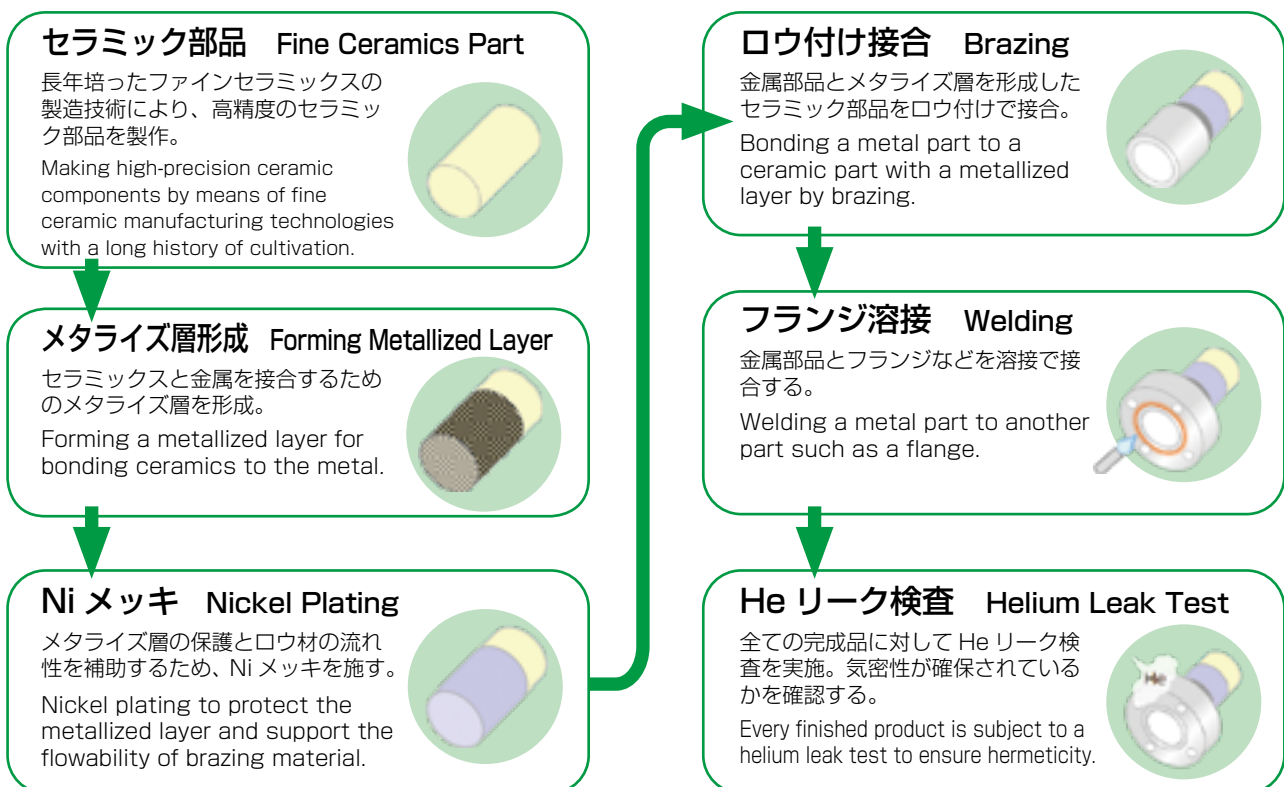

Ordering Process

製品の選定について

京セラでは気密端子のほか、金属フランジの取り付け、特殊形状の端子など、お客様のご要望に応じたカスタム対応も承っており、ご用途に対応する形状 / 材質選びのお手伝いをいたします。

In addition to the vacuum feedthrough of standard configuration, Kyocera can provide custom-made products including feedthroughs with a metal flange attached or those with a specific configuration. We will help customers to select the shapes/materials that meet their requirements.

	カタログ掲載品から選ぶ Choose from Kyocera's standard products	カスタム製作のご用命 Order customized products
Step.1 お問合せ Inquiries	各種端子部品の他、絶縁継手やサファイア窓など、取り揃えています。 Kyocera offers a variety of standard shape products including isolator flanges and sapphire windows as well as various feedthrough components. 製品のパーツナンバーをご連絡下さい。 Please inform us of the "Part Number" of the product.	ご要望の製品の詳細をご連絡下さい。 Please inform us of the details of the required product. <ul style="list-style-type: none"> - 図面 (形状がイメージできるもの) Drawing - 使用条件 Operating Conditions / 用途 Application ※差し支えない範囲で詳細をご連絡下さい Please share with us any applicable details. - 数量 Quantity - 納期 Required Delivery Date - その他ご要望やお困りの点 Other Requests or Issues
Step.2 ご提案 Proposal	ご要望に応じて詳細図面をお送りいたします。 We will send you the drawings upon request.	ご要望に対して可能な限り検討案を準備し、担当営業よりご一報します。 We will provide you with our proposal for a product that meets your requirements.
Step.3 ご注文 Order	合意を致しました仕様に基づき、製造を開始致します。 Production will begin according to the agreed-upon specifications and terms.	
Step.4 製造 Production	長年培った経験と製造技術により、ご要求に沿った製品を製造致します We meet your requests with our high-level expertise, wide-ranging technical capabilities and dependable production capacity	
Step.5 納品 Delivery		

■ 弊社からの供給内容 Services Provided by Kyocera

	気密部品 Feedthroughs	フランジ Flange	シール材 Sealing Part	チャンバー Chambers
カタログ掲載品 Catalog Spec	弊社 Kyocera	手配 / 取り付けはお客様にてご対応 Arrangement/installation are addressed by customers.		
カタログ掲載品 + フランジ Catalog Spec + Flange	弊社 Kyocera	※フランジの形状をお知らせ下さい Please inform us of the flange shape.	手配 / 取り付けはお客様にてご対応 Arrangement/installation are addressed by customers.	
カスタム製作のご用命 (Customized Products)	ご要望に応じて端子のみ⇄チャンバー含む製作まで承ります We will accommodate customers' requirements, ranging from only providing the required feedthrough to manufacturing the entire chamber.			

For Product Selection

製品選定ガイド

■気密端子 Vacuum Feedthroughs

気密端子は、ハーメチックシールなどとも呼ばれ、主にチャンバー内外の信号や電流の導入口として使用されています。京セラでは多ピン端子の他、同軸端子や電流導入端子を取り扱っており、ご要望に応じてフランジなどの接合も行います。

Vacuum feedthroughs, also called hermetic seals, feedthroughs, or vacuum current feedthroughs, are attached to chambers mainly for taking in and putting out signals or current. Kyocera can provide standard products including feedthroughs, coaxial feedthroughs and multi-pin terminal feedthroughs, and can accommodate customers' requirements such as flange bonding.

多ピン端子

Multi-Pin Feedthroughs

主に複数信号用

Mainly for multiple signals



→ P.12

同軸端子

Coaxial Connectors

主に高周波用

Mainly for high frequency



→ P.18

電流導入端子

Feedthroughs

主に大電流用

Mainly for high Current



→ P.27

■絶縁継手 Isolator Flanges

真空用の規格フランジに合わせた絶縁フランジです。標準寸法の外、ご希望の電圧、用途に合わせたものが製造可能です。

Isolator flanges for vacuum application. Standard sizes and custom-made flanges for voltage/usage requirements are available.



→ P.34

■サファイア窓 Sapphire Windows



単結晶サファイアを使った覗き窓です。真空用の規格フランジに合わせたサイズの外、耐圧用の窓の製作も行います。光学用の計測窓には、無反射コーティングを行うこともできます。

Single crystal sapphire is used. In addition to sizes for standard vacuum flanges, pressure-resistant windows are available. Antireflection coating is optional for the optical measurement window.



→ P.36

■ フランジの選定 (オプション) Flange selection (optional)

		フランジの取り付け方法 Methods of attaching flanges	
		クランプ Clamp	ボルト締め Bolting
シール方法 Sealing method	Oリング O-ring	KF/NW 	VF/VG 
	金属ガスケット Metal gasket		CF/ICF 

■ 製品設計時の条件 Conditions for Product Design

- 電圧 Voltage :
定格電圧ではなく、耐電圧 (試験電圧) を記載
Withstand voltage (test voltage) is described instead of rated voltage.
- 雰囲気 Atmosphere :
大気側 : 常温・常湿・1気圧の清浄な屋内
Outside, atmosphere: clean indoors, at normal temperature and humidity, 1 atm
真空側 : 高真空下 (1×10^{-1} Pa 以下)
Inside, vacuum: under high vacuum (1×10^{-1} Pa or less)
- 温度 Temperature :
低温温度 (Minimum temp.) : -196°C
高温温度 (Maximum temp.) : 450°C
* 弊社での基礎評価、判定基準に基づいた参考値です。
製品の形状や使用状況により異なる場合があります。
Note that these numbers are meant as reference only and are based on our basic evaluation and set criteria. The numbers may vary depending on the product's shape and usage.

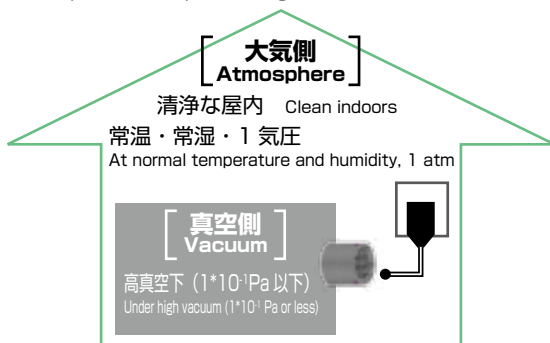

■ ご使用上の注意点 Precautions for Use

- 衝撃や無理な力をかけないでください。
Do not apply excessive force or impact.
- 大きな熱衝撃が加わると破損することがあります。
Might be damaged if thermal shock is applied.
- 汚れた場合、薬品や水を使って洗浄しないでください。アルコール等を浸み込ませたガーゼで軽くふき取ってください。
Do not use chemicals or water to wash away dirt. Lightly wipe off dirt with gauze soaked in alcohol or similar.
- ロウ付けで加熱処理された銅材は、一般より柔らかくなります。
Heat-processed brazing copper material is softer than conventional products.
- 製品とケーブルをボルト・ナット等で結線する場合、ロウ付け部に大きな力が加わらないようにしてください。
Do not apply excessive force to the brazed part when connecting products and cables with bolts / nuts.
- 溶接時は入熱量を加減してください (セラミックス近辺が 60°C 以下が望ましい)
Adjust the heat input while welding (60°C or less in the vicinity of ceramics).
- エポキシ樹脂などでピン部をモールドしないでください。熱膨張差が大きくセラミックスやピンのシール部が割れる恐れがあります。
Do not mold pins with epoxy resin; it might cause cracks on the sealed parts of ceramics and pins due to significant differences in thermal expansion.
- 製品に電流を流すと発熱します。配線の際、温度が上がりすぎないように、ご注意ください。
Current flows in the product can generate heat. Please ensure that the temperature does not rise too much when wiring.

Circular Multi-Pin Feedthroughs

丸形多ピン端子

計測・制御用の丸形多ピンフィードスルーです。バイヨネットロック型のプラグ、MIL規格準拠のプラグ、それぞれと組み合わせが可能な製品があります。ストレートチューブ構造の他、Oリングシール可能なフランジ付きのもの、スリーブの材質をアルミニウムへの変更が可能です。

Circular multi-pin terminal feedthroughs for measurement and control use. Compatible with Bayonet lock socket or MIL standard compliant socket. In addition to straight tube configuration, Kyocera can fabricate various shapes and types including those with flanges for O-ring-seals, with aluminum sleeves, or with K and T thermocouples.

■ Bayonet Lock Series (Burndy)



バイヨネットタイプで容易に脱着が可能な多ピン端子で、バイヨネット用のボスがあるのが特徴です。

Bayonet-type featuring multipin terminals for easy detachment and dedicated boss for Bayonet.

■ MS Series



MIL規格準拠のプラグと組み合わせが可能な多ピン端子で、ネジ山の加工が施されています。

Multi-pin terminal feedthroughs compatible with MIL standard compliant socket.

■ (Bayonet Lock Series) プラグの組み合わせ例

(Bayonet Lock Series) Applications in Combined Sockets

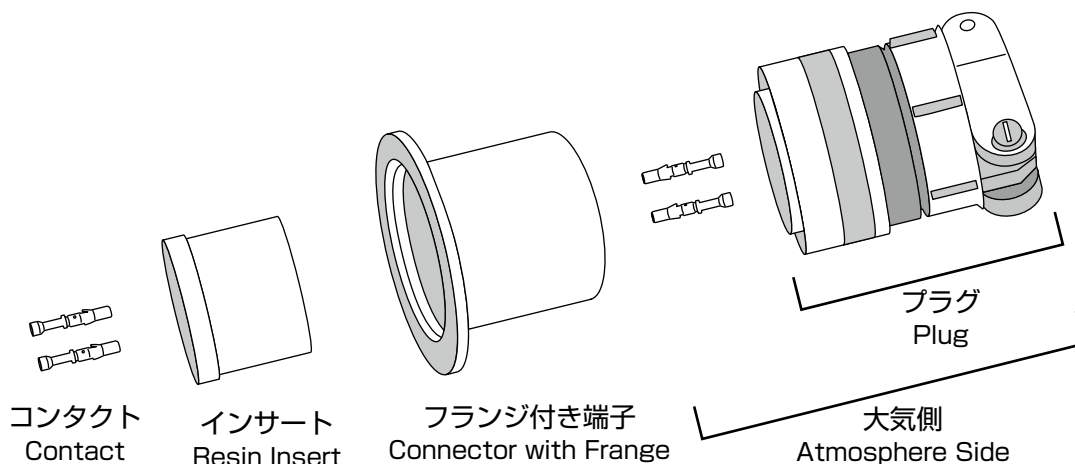

Multipin Connectors

Bayonet Lock Series

4PIN

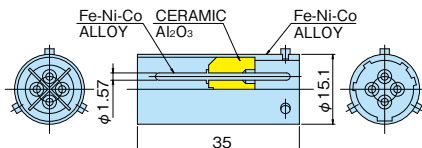

Part Number	22320
許容電流値 Current [A max]	3
耐電圧 Voltage [V max]	D.C 500
気密度 Leak rate [1.3xPa · m ³ /s]	10 ⁻¹⁰
* 絶縁抵抗 Insulation [Ω min.]	10 ⁹
* 高温温度 Max. Temp. [deg.C]	450
* 低温温度 Min. Temp. [deg.C]	-196
プラグ Plug	G6A10-4SNE-JG
[Option] インサート Resin Insert	G10-4S
コンタクト Contact	RC20M-13ELD28

8PIN

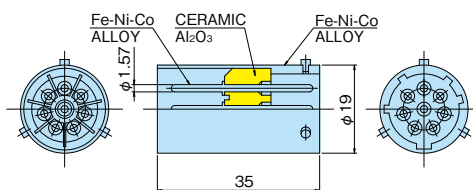

Part Number	18787
許容電流値 Current [A max]	3
耐電圧 Voltage [V max]	D.C 500
気密度 Leak rate [1.3xPa · m ³ /s]	10 ⁻¹⁰
* 絶縁抵抗 Insulation [Ω min.]	10 ⁹
* 高温温度 Max. Temp. [deg.C]	450
* 低温温度 Min. Temp. [deg.C]	-196
プラグ Plug	G6A12-88SNE-JG
[Option] インサート Resin Insert	G12-88S
コンタクト Contact	RC20M-13ELD28

12PIN

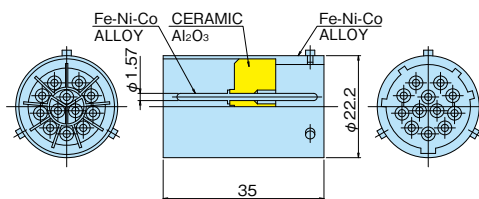

Part Number	18955
許容電流値 Current [A max]	3
耐電圧 Voltage [V max]	D.C 500
気密度 Leak rate [1.3xPa · m ³ /s]	10 ⁻¹⁰
* 絶縁抵抗 Insulation [Ω min.]	10 ⁹
* 高温温度 Max. Temp. [deg.C]	450
* 低温温度 Min. Temp. [deg.C]	-196
プラグ Plug	G6A14-92SNE-JG
[Option] インサート Resin Insert	G14-92S
コンタクト Contact	RC20M-13ELD28

19PIN

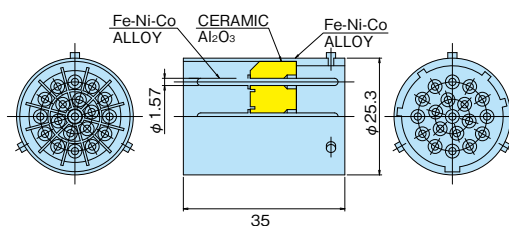

Part Number	90474
許容電流値 Current [A max]	3
耐電圧 Voltage [V max]	D.C 500
気密度 Leak rate [1.3xPa · m ³ /s]	10 ⁻¹⁰
* 絶縁抵抗 Insulation [Ω min.]	10 ⁹
* 高温温度 Max. Temp. [deg.C]	450
* 低温温度 Min. Temp. [deg.C]	-196
プラグ Plug	G6A16-19SNE-JG
[Option] インサート Resin Insert	G16-19S
コンタクト Contact	RC20M-13ELD28

* 弊社での基礎評価、判定基準に基づいた参考値です。特性値は使用状況により異なる場合があります。
 Note that these numbers are meant as reference only and are based on our basic evaluation and set criteria.
 The numbers may vary depending on the product's usage.

Multipin Connectors

Bayonet Lock Series

22PIN (Aluminum Sleeve へ変更可能)

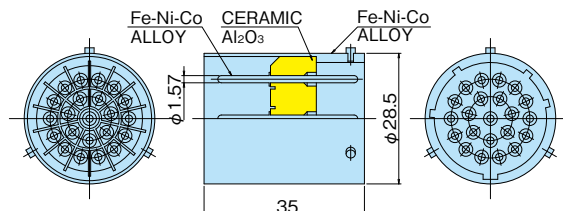

Part Number	14820
許容電流値 Current [A max]	3
耐電圧 Voltage [V max]	D.C 500
気密度 Leak rate [1.3xPa · m ³ /s]	10 ⁻¹⁰
* 絶縁抵抗 Insulation [Ω min.]	10 ⁹
* 高温温度 Max. Temp. [deg.C]	450
* 低温温度 Min. Temp. [deg.C]	-196
プラグ Plug	G6A18-22SNE-JG
[Option] インサート Resin Insert	G18-22S
コンタクト Contact	RC20M-13ELD28

22PIN-Through

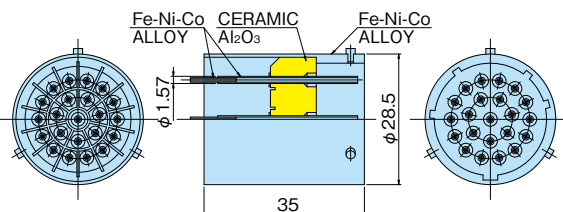

Part Number	16891
許容電流値 Current [A max]	3
耐電圧 Voltage [V max]	D.C 500
気密度 Leak rate [1.3xPa · m ³ /s]	10 ⁻¹⁰
* 絶縁抵抗 Insulation [Ω min.]	10 ⁹
* 高温温度 Max. Temp. [deg.C]	450
* 低温温度 Min. Temp. [deg.C]	-196
プラグ Plug	G6A18-22SNE-JG
[Option] インサート Resin Insert	G18-22S
コンタクト Contact	RC20M-13ELD28

30PIN

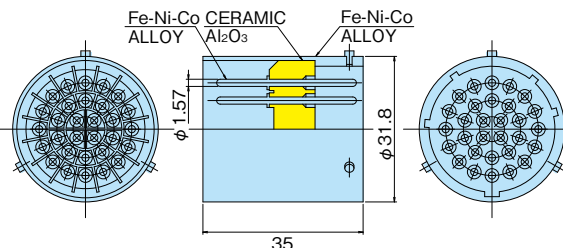

Part Number	90366
許容電流値 Current [A max]	3
耐電圧 Voltage [V max]	D.C 500
気密度 Leak rate [1.3xPa · m ³ /s]	10 ⁻¹⁰
* 絶縁抵抗 Insulation [Ω min.]	10 ⁹
* 高温温度 Max. Temp. [deg.C]	450
* 低温温度 Min. Temp. [deg.C]	-196
プラグ Plug	G6A20-30SNE-JG
[Option] インサート Resin Insert	G20-30S
コンタクト Contact	RC20M-13ELD28

48PIN (Aluminum Sleeve へ変更可能)

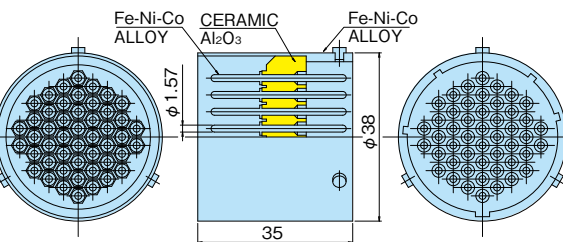
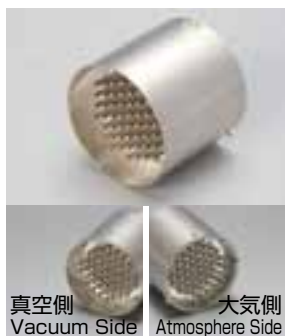

Part Number	16522
許容電流値 Current [A max]	3
耐電圧 Voltage [V max]	D.C 500
気密度 Leak rate [1.3xPa · m ³ /s]	10 ⁻¹⁰
* 絶縁抵抗 Insulation [Ω min.]	10 ⁹
* 高温温度 Max. Temp. [deg.C]	450
* 低温温度 Min. Temp. [deg.C]	-196
プラグ Plug	G6A24-48SNE-JG
[Option] インサート Resin Insert	G24-48S
コンタクト Contact	RC20M-13ELD28

* 弊社での基礎評価、判定基準に基づいた参考値です。特性値は使用状況により異なる場合があります。
 Note that these numbers are meant as reference only and are based on our basic evaluation and set criteria.
 The numbers may vary depending on the product's usage.

Multipin Connectors (Hermetic Seal Type)

Bayonet Lock Series

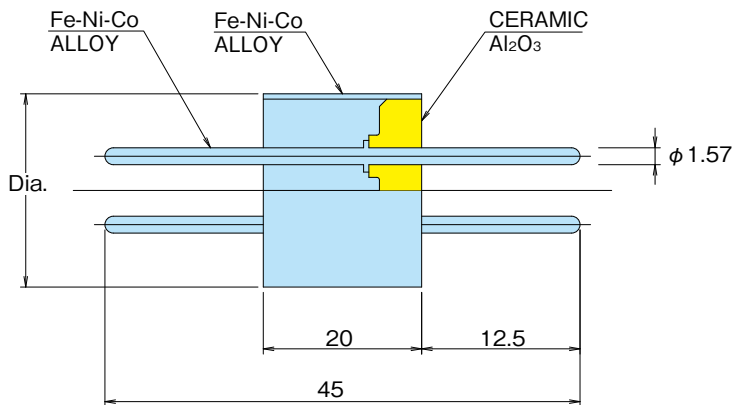
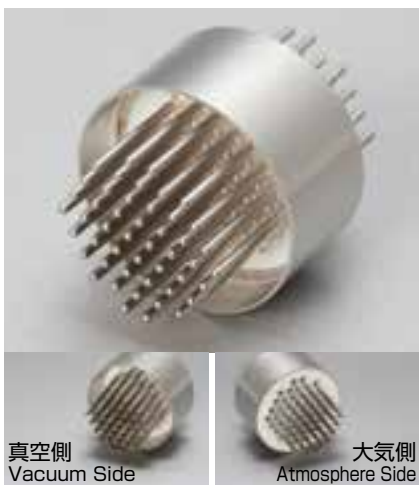

4PIN
Φ15.1mm

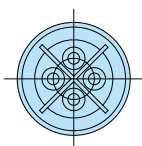

8PIN
Φ19.0mm

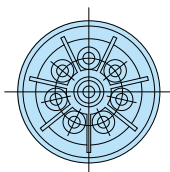

12PIN
Φ22.2mm

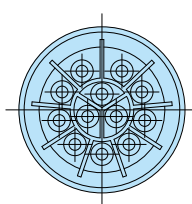

19PIN
Φ25.3mm

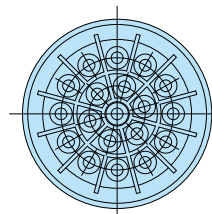

22PIN
Φ28.5mm

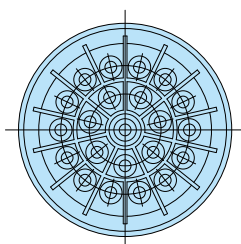

30PIN
Φ31.8mm

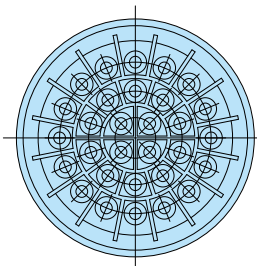

48PIN
Φ38.0mm

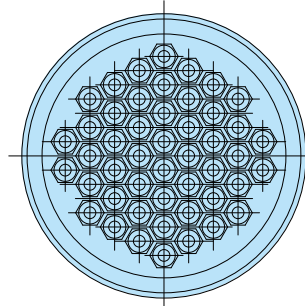

Part Number	Pin Qty	SPEC					
		許容電流値 Current [A max]	耐電圧 Voltage [V max]	* 絶縁抵抗 Insulation [Ω min.]	気密度 Leak rate [1.3xPa · m ³ /s]	* 高温温度 Max. Temp. [deg. C]	* 低温温度 Min. Temp. [deg. C]
90529	4PIN	3	D.C 500	10 ⁹	10 ⁻¹⁰	450	-196
90530	8PIN						
90531	12PIN						
90532	19PIN						
90533	22PIN						
90534	30PIN						
90535	48PIN						

* 弊社での基礎評価、判定基準に基づいた参考値です。特性値は使用状況により異なる場合があります。
 Note that these numbers are meant as reference only and are based on our basic evaluation and set criteria.
 The numbers may vary depending on the product's usage.

Multipin Connectors

MS Series

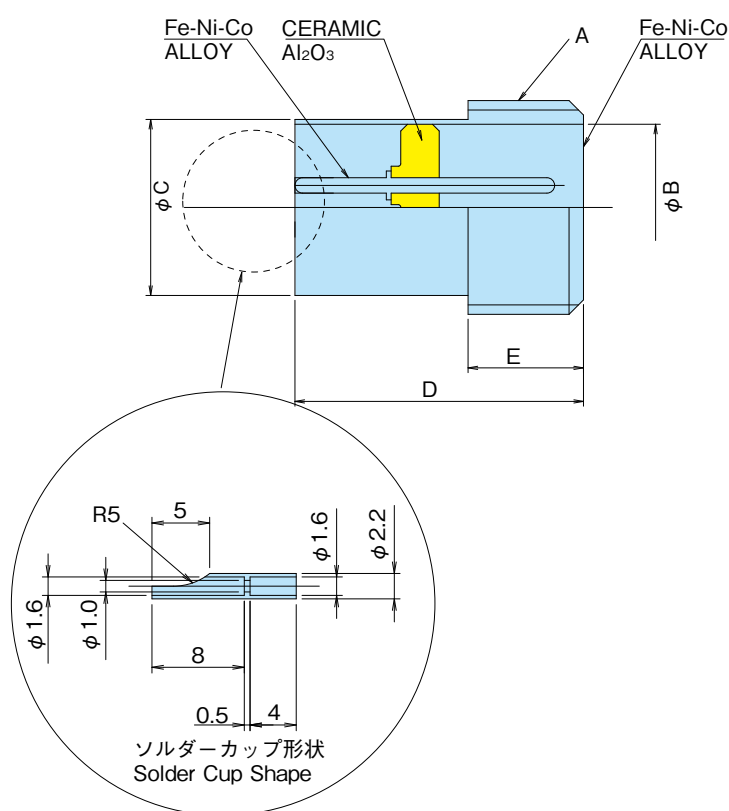

ソルダーカップ有りの対応も可。
Correspondence with Solder Cup is possible, too

Part Number	SHELL SIZE	Pin Qty	Pin Dia.	A	B	C	D	E	SPEC					
									許容電流値 Current [A max]	耐電圧 Voltage [V max]	*絶縁抵抗 Insulation [Ω min.]	気密度 Leak rate [1.3xPa·m ³ /s]	*高温温度 Max. Temp. [deg. C]	*低温温度 Min. Temp. [deg. C]
A8103	12S-3	2PIN	φ 1.6	.750-20UNEF	14.2	15.2	30	12	3	D.C 500	10 ⁹	10 ⁻¹⁰	450	-196
A0647	14S-7	3PIN	φ 1.6	.875-20UNEF	17.3	18.3	30	12						
B1186	14S-2	4PIN	φ 1.6	.875-20UNEF	17.3	18.3	30	12						
93192	14S-6	6PIN	φ 1.6	.875-20UNEF	17.3	18.3	30	12						
B7760	18-11	5PIN	φ 2.4	1.125-18UNEF	23.7	25.2	49	18						
97B76	18-1	10PIN	φ 1.6	1.125-18UNEF	23.7	25.2	49	18						
A7057	20-27	14PIN	φ 1.6	1.250-18UNEF	26.8	28.3	49	18						
B7761	22-23	8PIN	φ 2.4	1.375-18UNEF	30	31.5	49	18						
91537	22-14	19PIN	φ 1.6	1.375-18UNEF	30	31.5	49	18						
91538	24-28	24PIN	φ 1.6	1.500-18UNEF	33.1	34.6	49	18						
B7762	28-6	3PIN	φ 5.7	1.750-18UNS	38.7	40.7	49	18	15					
B7763	28-12	26PIN	φ 1.6	1.750-18UNS	38.7	40.7	49	18	3	D.C 500	10 ⁹	10 ⁻¹⁰	450	-196
A0618	28-21	37PIN	φ 1.6	1.750-18UNS	38.7	40.7	49	18						
93365	36-10	48PIN	φ 1.6	2.250-16UNS	50.4	52.4	49	18						

* 弊社での基礎評価、判定基準に基づいた参考値です。特性値は使用状況により異なる場合があります。
Note that these numbers are meant as reference only and are based on our basic evaluation and set criteria.
The numbers may vary depending on the product's usage.

Multipin Connectors (Hermetic Seal Type)

MS Series

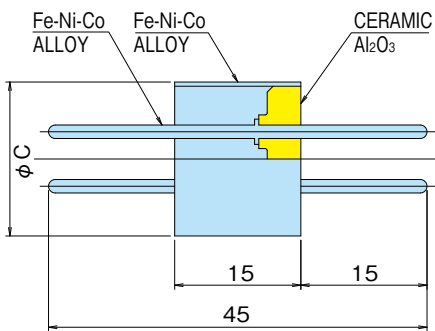

MS SERIES		WIRE No(#4 · 12 · 16) SHELL SIZE: 12S · 14S 18 · 20 · 22 · 24 · 28 · 36		PIN 1/0 WIRE No	SHELL SIZE NUMBERING SYMBOL
2 #16 (ピン径) φ1.6	12S-3	6 #16 (ピン径) φ1.6	14S-6	24 #16 (ピン径) φ1.6	24-28
3 #16 (ピン径) φ1.6	14S-7	8 #12 (ピン径) φ2.4	22-23	26 #16 (ピン径) φ1.6	28-12
3 #4 (ピン径) φ5.7	28-6	10 #16 (ピン径) φ1.6	18-1	37 #16 (ピン径) φ1.6	28-21
4 #16 (ピン径) φ1.6	14S-2	14 #16 (ピン径) φ1.6	20-27	48 #16 (ピン径) φ1.6	36-10
5 #12 (ピン径) φ2.4	18-11	19 #16 (ピン径) φ1.6	22-14		

Part Number	SHELL SIZE	Pin Qty	Pin Dia.	C	SPEC						
					許容電流値 Current [A max]	耐電圧 Voltage [V max]	* 絶縁抵抗 Insulation [Ω min.]	気密度 Leak rate [1.3xPa · m ³ /s]	* 高温温度 Max. Temp. [deg. C]	* 低温温度 Min. Temp. [deg. C]	
90578	12S-3	2PIN	φ 1.6	15.2	3	D.C 500	10 ⁹	10 ⁻¹⁰	450	-196	
90579	14S-7	3PIN	φ 1.6	18.3							
90581	14S-2	4PIN	φ 1.6	18.3							
90583	14S-6	6PIN	φ 1.6	18.3							
90582	18-11	5PIN	φ 2.4	25.2							
90585	18-1	10PIN	φ 1.6	25.2							
90586	20-27	14PIN	φ 1.6	28.3							
90584	22-23	8PIN	φ 2.4	31.5							
90587	22-14	19PIN	φ 1.6	31.5							
90588	24-28	24PIN	φ 1.6	34.6							
90580	28-6	3PIN	φ 5.7	40.7							15
90589	28-12	26PIN	φ 1.6	40.7							
92466	28-21	37PIN	φ 1.6	40.7							3
90591	36-10	48PIN	φ 1.6	47.1							

* 弊社での基礎評価、判定基準に基づいた参考値です。特性値は使用状況により異なる場合があります。
 Note that these numbers are meant as reference only and are based on our basic evaluation and set criteria.
 The numbers may vary depending on the product's usage.

Coaxial Connectors

同軸端子

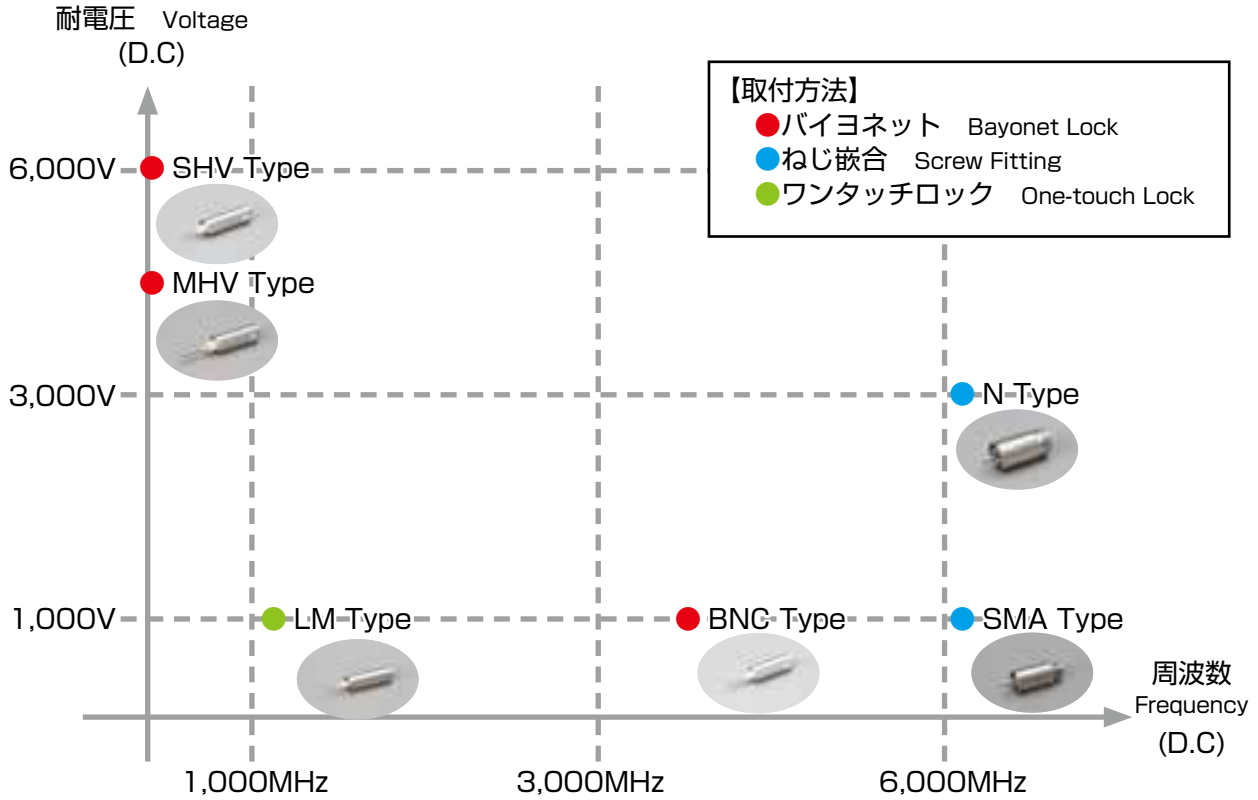

■ グランドシールド Grounded Shield

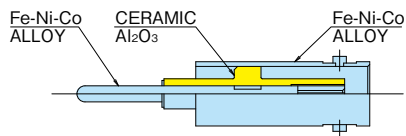

一般的な気密端子です。
Conventional vacuum feedthrough

■ フローティングシールド Floating Shield

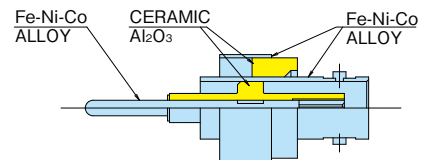

端子部分をフランジ等の取り付け部分から完全に独立させ、周囲の環境による影響（ノイズ等）を受けにくい構造の気密端子です。

It has a construction that is less susceptible to the influences of the surrounding environment (noise, etc.) due to the complete separation of the terminal part from the attachment part of the flange, etc.

Coaxial Connectors

同軸端子

製品の高周波特性 (例) *

Product RF Characteristics (Example) *

■BNC-JJ

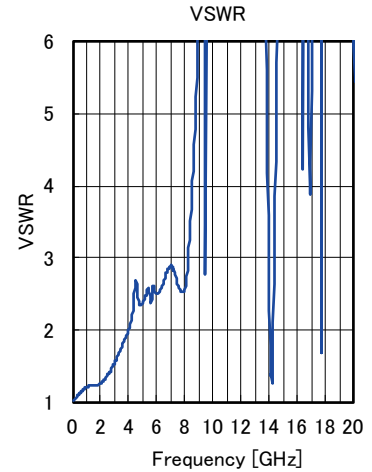
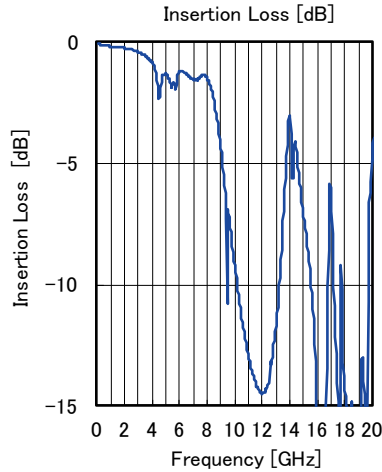
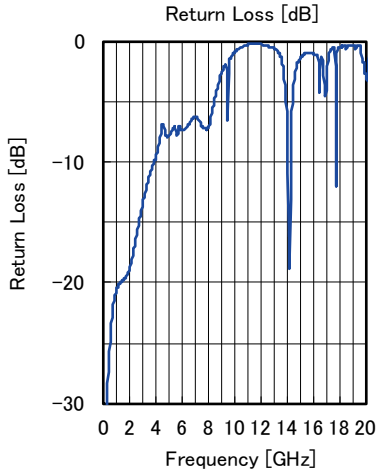

■N-JJ

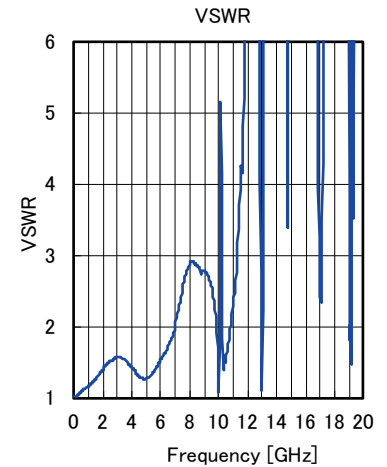
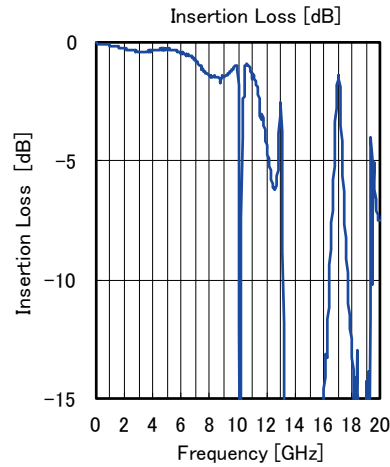
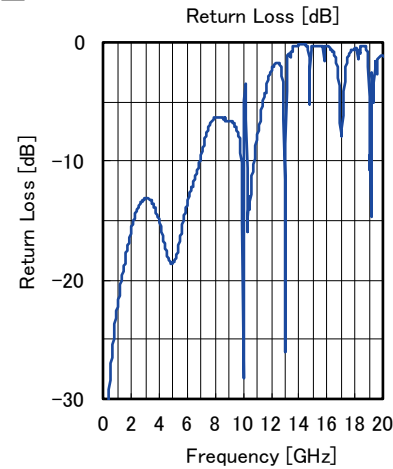

■SMA-JJ

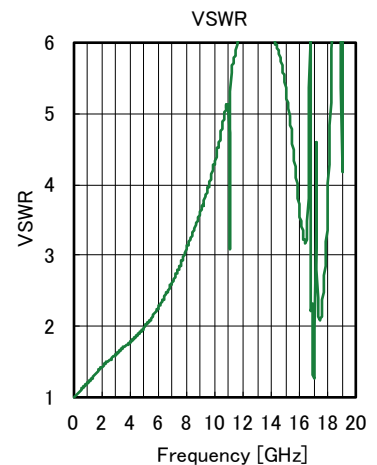
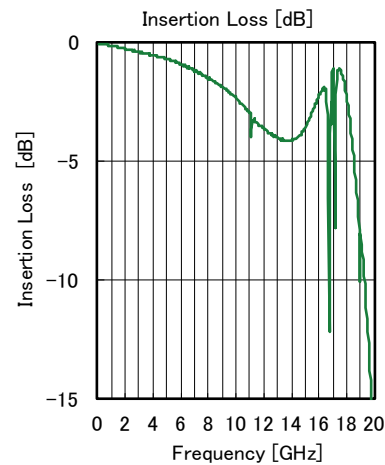
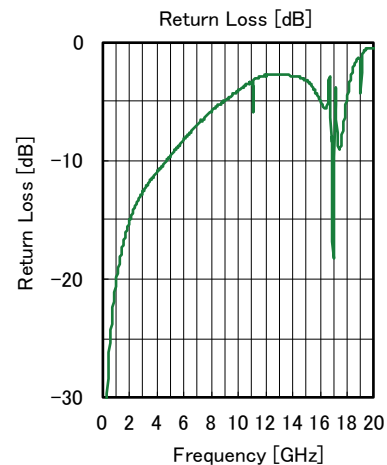

* 弊社での基礎評価、判定基準に基づいた参考値です。特性値は使用状況により異なる場合があります。
 Note that these numbers are meant as reference only and are based on our basic evaluation and set criteria.
 The numbers may vary depending on the product's usage.

Coaxial Connectors

同軸端子

BNC-R

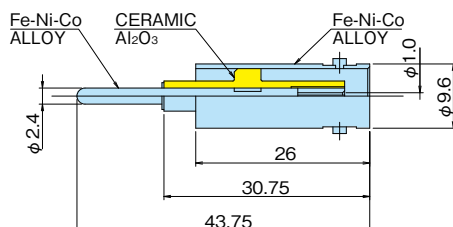

Part Number	16155
TYPE	-
許容電流値 Current [A max]	3
耐電圧 Voltage [V max]	D.C 1,000
抵抗 Impedance [Ω]	50
気密度 Leak rate [1.3xPa · m ³ /s]	10 ⁻¹⁰
* 絶縁抵抗 Insulation [Ω min.]	10 ⁹
* 高温温度 Max. Temp. [deg. C]	450
* 低温温度 Min. Temp. [deg. C]	-196
[Option] プラグ Plug	BNC-P-3
コンタクト Contact	-

BNC-R-F

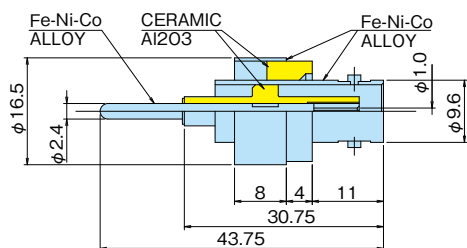

Part Number	14516
TYPE	Floating
許容電流値 Current [A max]	3
耐電圧 Voltage [V max]	D.C 1,000
抵抗 Impedance [Ω]	50
気密度 Leak rate [1.3xPa · m ³ /s]	10 ⁻¹⁰
* 絶縁抵抗 Insulation [Ω min.]	10 ⁹
* 高温温度 Max. Temp. [deg. C]	450
* 低温温度 Min. Temp. [deg. C]	-196
[Option] プラグ Plug	BNC-P-3
コンタクト Contact	-

BNC-JJ

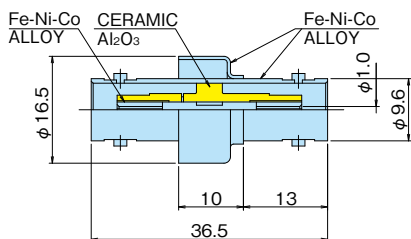

Part Number	15760
TYPE	-
許容電流値 Current [A max]	3
耐電圧 Voltage [V max]	D.C 1,000
抵抗 Impedance [Ω]	50
気密度 Leak rate [1.3xPa · m ³ /s]	10 ⁻¹⁰
* 絶縁抵抗 Insulation [Ω min.]	10 ⁹
* 高温温度 Max. Temp. [deg. C]	450
* 低温温度 Min. Temp. [deg. C]	-196
[Option] プラグ Plug	BNC-P-3
コンタクト Contact	-

BNC-JJ-F

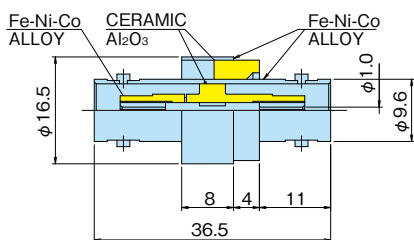

Part Number	15759
TYPE	Floating
許容電流値 Current [A max]	3
耐電圧 Voltage [V max]	D.C 1,000
抵抗 Impedance [Ω]	50
気密度 Leak rate [1.3xPa · m ³ /s]	10 ⁻¹⁰
* 絶縁抵抗 Insulation [Ω min.]	10 ⁹
* 高温温度 Max. Temp. [deg. C]	450
* 低温温度 Min. Temp. [deg. C]	-196
[Option] プラグ Plug	BNC-P-3
コンタクト Contact	-

* 弊社での基礎評価、判定基準に基づいた参考値です。特性値は使用状況により異なる場合があります。
 Note that these numbers are meant as reference only and are based on our basic evaluation and set criteria.
 The numbers may vary depending on the product's usage.

Coaxial Connectors

同軸端子

BNC-R-M2 SCREW

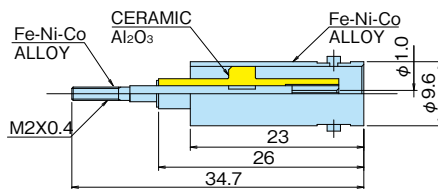

Part Number	17290
TYPE	-
許容電流値 Current [A max]	3
耐電圧 Voltage [V max]	D.C 1,000
抵抗 Impedance [Ω]	50
気密度 Leak rate [1.3xPa · m ³ /s]	10 ⁻¹⁰
* 絶縁抵抗 Insulation [Ω min.]	10 ⁹
* 高温温度 Max. Temp. [deg. C]	450
* 低温温度 Min. Temp. [deg. C]	-196
[Option] プラグ Plug	BNC-P-3
コンタクト Contact	-

BNC-R-F-M2 SCREW

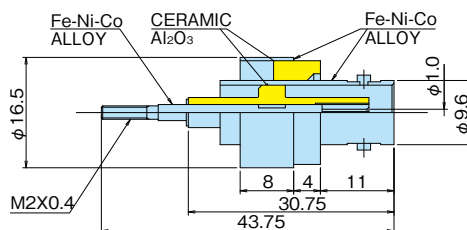

Part Number	90166
TYPE	Floating
許容電流値 Current [A max]	3
耐電圧 Voltage [V max]	D.C 1,000
抵抗 Impedance [Ω]	50
気密度 Leak rate [1.3xPa · m ³ /s]	10 ⁻¹⁰
* 絶縁抵抗 Insulation [Ω min.]	10 ⁹
* 高温温度 Max. Temp. [deg. C]	450
* 低温温度 Min. Temp. [deg. C]	-196
[Option] プラグ Plug	BNC-P-3
コンタクト Contact	-

5KV-BNC-R

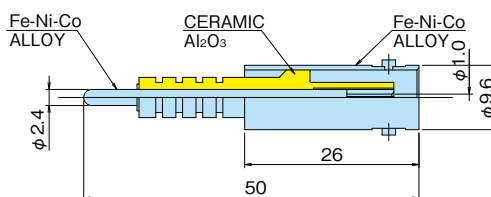

Part Number	94331
TYPE	-
許容電流値 Current [A max]	3
耐電圧 Voltage [V max]	D.C 5,000
抵抗 Impedance [Ω]	50
気密度 Leak rate [1.3xPa · m ³ /s]	10 ⁻¹⁰
* 絶縁抵抗 Insulation [Ω min.]	10 ⁹
* 高温温度 Max. Temp. [deg. C]	450
* 低温温度 Min. Temp. [deg. C]	-196
[Option] プラグ Plug	11H4-50-4-4
コンタクト Contact	-

15KV-F-Coaxial

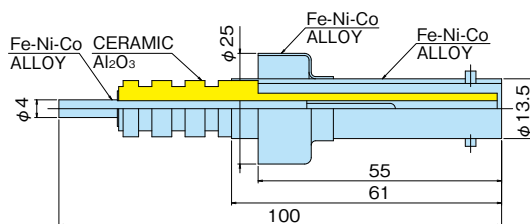

Part Number	A5051
TYPE	-
許容電流値 Current [A max]	10
耐電圧 Voltage [V max]	D.C 15,000
抵抗 Impedance [Ω]	50
気密度 Leak rate [1.3xPa · m ³ /s]	10 ⁻¹⁰
* 絶縁抵抗 Insulation [Ω min.]	10 ⁹
* 高温温度 Max. Temp. [deg. C]	450
* 低温温度 Min. Temp. [deg. C]	-196
[Option] プラグ Plug	-
コンタクト Contact	-

* 弊社での基礎評価、判定基準に基づいた参考値です。特性値は使用状況により異なる場合があります。
 Note that these numbers are meant as reference only and are based on our basic evaluation and set criteria.
 The numbers may vary depending on the product's usage.

Coaxial Connectors

同軸端子

SHV-R

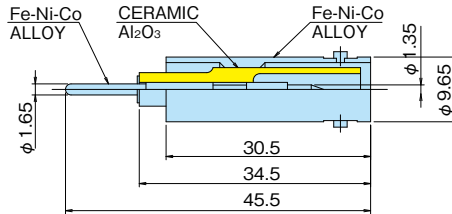

Part Number	17847
TYPE	-
許容電流値 Current [A max]	3
耐電圧 Voltage [V max]	D.C 6,000
抵抗 Impedance [Ω]	50
気密度 Leak rate [1.3xPa · m ³ /s]	10 ⁻¹⁰
* 絶縁抵抗 Insulation [Ω min.]	10 ⁹
* 高温温度 Max. Temp. [deg. C]	450
* 低温温度 Min. Temp. [deg. C]	-196
[Option] プラグ Plug	11SHV50-4-1C
コンタクト Contact	RC20M-13ELD28

SHV-R-F

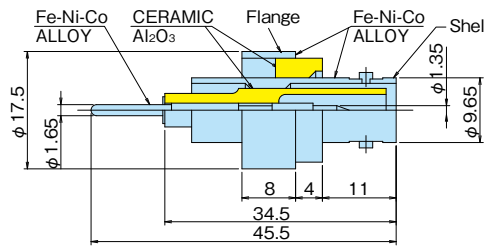

Part Number	90162
TYPE	Floating
許容電流値 Current [A max]	3
耐電圧 Voltage [V max]	D.C 6,000 (Shell-to-Flange D.C 1,000)
抵抗 Impedance [Ω]	50
気密度 Leak rate [1.3xPa · m ³ /s]	10 ⁻¹⁰
* 絶縁抵抗 Insulation [Ω min.]	10 ⁹
* 高温温度 Max. Temp. [deg. C]	450
* 低温温度 Min. Temp. [deg. C]	-196
[Option] プラグ Plug	11SHV50-4-1C
コンタクト Contact	RC20M-13ELD28

SHV-JJ

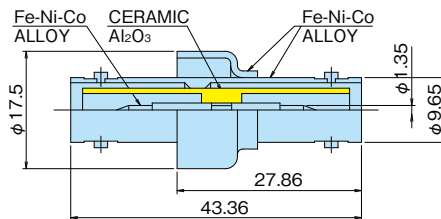

Part Number	90165
TYPE	-
許容電流値 Current [A max]	3
耐電圧 Voltage [V max]	D.C 6,000
抵抗 Impedance [Ω]	50
気密度 Leak rate [1.3xPa · m ³ /s]	10 ⁻¹⁰
* 絶縁抵抗 Insulation [Ω min.]	10 ⁹
* 高温温度 Max. Temp. [deg. C]	450
* 低温温度 Min. Temp. [deg. C]	-196
[Option] プラグ Plug	11SHV50-4-1C
コンタクト Contact	-

SHV-JJ-F

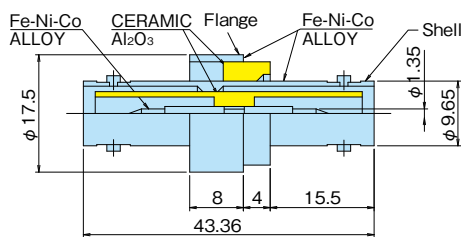

Part Number	85205
TYPE	Floating
許容電流値 Current [A max]	3
耐電圧 Voltage [V max]	D.C 6,000 (Shell-to-Flange D.C 1,000)
抵抗 Impedance [Ω]	50
気密度 Leak rate [1.3xPa · m ³ /s]	10 ⁻¹⁰
* 絶縁抵抗 Insulation [Ω min.]	10 ⁹
* 高温温度 Max. Temp. [deg. C]	450
* 低温温度 Min. Temp. [deg. C]	-196
[Option] プラグ Plug	11SHV50-4-1C
コンタクト Contact	-

* 弊社での基礎評価、判定基準に基づいた参考値です。特性値は使用状況により異なる場合があります。
 Note that these numbers are meant as reference only and are based on our basic evaluation and set criteria.
 The numbers may vary depending on the product's usage.

Coaxial Connectors

同軸端子

MHV-R

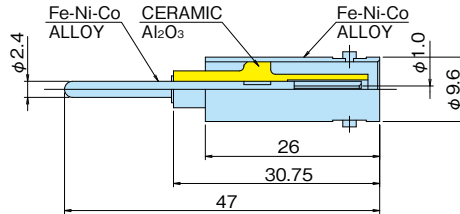

Part Number	86537
TYPE	-
許容電流値 Current [A max]	3
耐電圧 Voltage [V max]	D.C 5,000
抵抗 Impedance [Ω]	50
気密度 Leak rate [1.3xPa · m ³ /s]	10 ⁻¹⁰
* 絶縁抵抗 Insulation [Ω min.]	10 ⁹
* 高温温度 Max. Temp. [deg. C]	450
* 低温温度 Min. Temp. [deg. C]	-196
[Option] プラグ Plug	11H4-50-4-4
コンタクト Contact	-

MHV-R-F

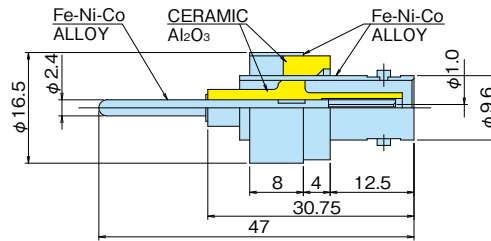

Part Number	90179
TYPE	Floating
許容電流値 Current [A max]	3
耐電圧 Voltage [V max]	D.C 5,000
抵抗 Impedance [Ω]	50
気密度 Leak rate [1.3xPa · m ³ /s]	10 ⁻¹⁰
* 絶縁抵抗 Insulation [Ω min.]	10 ⁹
* 高温温度 Max. Temp. [deg. C]	450
* 低温温度 Min. Temp. [deg. C]	-196
[Option] プラグ Plug	11H4-50-4-4
コンタクト Contact	-

MHV-JJ

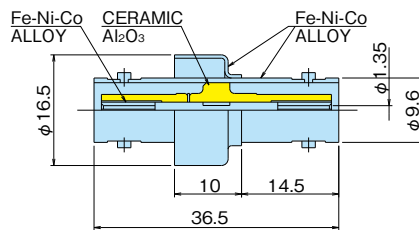

Part Number	20414
TYPE	-
許容電流値 Current [A max]	3
耐電圧 Voltage [V max]	D.C 5,000
抵抗 Impedance [Ω]	50
気密度 Leak rate [1.3xPa · m ³ /s]	10 ⁻¹⁰
* 絶縁抵抗 Insulation [Ω min.]	10 ⁹
* 高温温度 Max. Temp. [deg. C]	450
* 低温温度 Min. Temp. [deg. C]	-196
[Option] プラグ Plug	11H4-50-4-4
コンタクト Contact	-

MHV-JJ-F

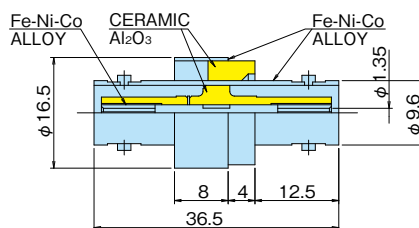

Part Number	18737
TYPE	Floating
許容電流値 Current [A max]	3
耐電圧 Voltage [V max]	D.C 5,000
抵抗 Impedance [Ω]	50
気密度 Leak rate [1.3xPa · m ³ /s]	10 ⁻¹⁰
* 絶縁抵抗 Insulation [Ω min.]	10 ⁹
* 高温温度 Max. Temp. [deg. C]	450
* 低温温度 Min. Temp. [deg. C]	-196
[Option] プラグ Plug	11H4-50-4-4
コンタクト Contact	-

* 弊社での基礎評価、判定基準に基づいた参考値です。特性値は使用状況により異なる場合があります。
Note that these numbers are meant as reference only and are based on our basic evaluation and set criteria.
The numbers may vary depending on the product's usage.

Coaxial Connectors

同軸端子

N-R

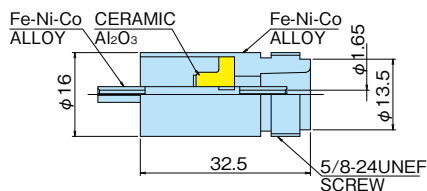

Part Number	16297
TYPE	-
許容電流値 Current [A max]	5
耐電圧 Voltage [V max]	D.C 3,000
抵抗 Impedance [Ω]	50
気密度 Leak rate [1.3xPa · m ³ /s]	10 ⁻¹⁰
* 絶縁抵抗 Insulation [Ω min.]	10 ⁹
* 高温温度 Max. Temp. [deg. C]	450
* 低温温度 Min. Temp. [deg. C]	-196
[Option] プラグ Plug	N-P-58U
コンタクト Contact	RM20M-13D28

N-R-F

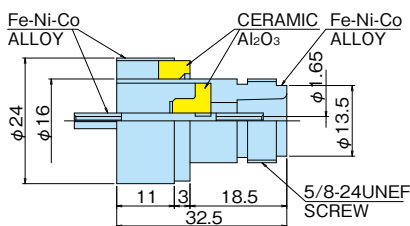

Part Number	16632
TYPE	Floating
許容電流値 Current [A max]	5
耐電圧 Voltage [V max]	D.C 3,000
抵抗 Impedance [Ω]	50
気密度 Leak rate [1.3xPa · m ³ /s]	10 ⁻¹⁰
* 絶縁抵抗 Insulation [Ω min.]	10 ⁹
* 高温温度 Max. Temp. [deg. C]	450
* 低温温度 Min. Temp. [deg. C]	-196
[Option] プラグ Plug	N-P-58U
コンタクト Contact	RM20M-13D28

N-JJ

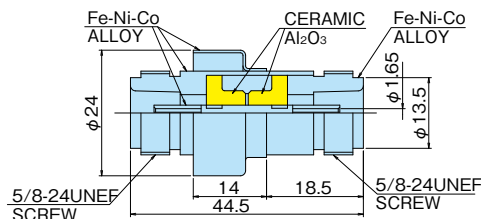

Part Number	16634
TYPE	-
許容電流値 Current [A max]	5
耐電圧 Voltage [V max]	D.C 3,000
抵抗 Impedance [Ω]	50
気密度 Leak rate [1.3xPa · m ³ /s]	10 ⁻¹⁰
* 絶縁抵抗 Insulation [Ω min.]	10 ⁹
* 高温温度 Max. Temp. [deg. C]	450
* 低温温度 Min. Temp. [deg. C]	-196
[Option] プラグ Plug	N-P-58U
コンタクト Contact	-

N-JJ-F

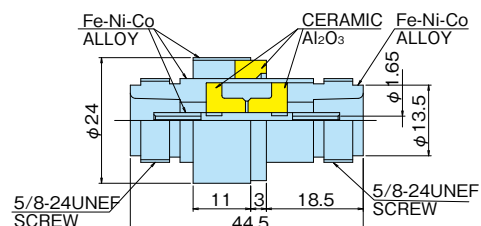

Part Number	16633
TYPE	Floating
許容電流値 Current [A max]	5
耐電圧 Voltage [V max]	D.C 3,000
抵抗 Impedance [Ω]	50
気密度 Leak rate [1.3xPa · m ³ /s]	10 ⁻¹⁰
* 絶縁抵抗 Insulation [Ω min.]	10 ⁹
* 高温温度 Max. Temp. [deg. C]	450
* 低温温度 Min. Temp. [deg. C]	-196
[Option] プラグ Plug	N-P-58U
コンタクト Contact	-

* 弊社での基礎評価、判定基準に基づいた参考値です。特性値は使用状況により異なる場合があります。
 Note that these numbers are meant as reference only and are based on our basic evaluation and set criteria.
 The numbers may vary depending on the product's usage.

Coaxial Connectors

同軸端子

SMA-R

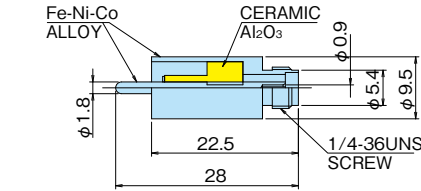

Part Number	17545
TYPE	-
許容電流値 Current [A max]	3
耐電圧 Voltage [V max]	D.C 1,000
抵抗 Impedance [Ω]	50
気密度 Leak rate [1.3xPa · m ³ /s]	10 ⁻¹⁰
* 絶縁抵抗 Insulation [Ω min.]	10 ⁹
* 高温温度 Max. Temp. [deg. C]	450
* 低温温度 Min. Temp. [deg. C]	-196
[Option] プラグ Plug	11SMA-50-3-7C
[Option] コンタクト Contact	-

SMA-R-F

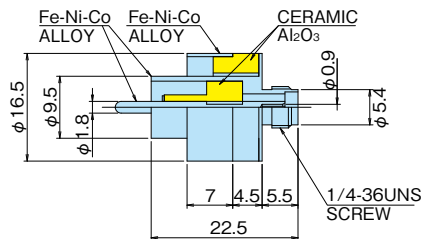

Part Number	90174
TYPE	Floating
許容電流値 Current [A max]	3
耐電圧 Voltage [V max]	D.C 1,000
抵抗 Impedance [Ω]	50
気密度 Leak rate [1.3xPa · m ³ /s]	10 ⁻¹⁰
* 絶縁抵抗 Insulation [Ω min.]	10 ⁹
* 高温温度 Max. Temp. [deg. C]	450
* 低温温度 Min. Temp. [deg. C]	-196
[Option] プラグ Plug	11SMA-50-3-7C
[Option] コンタクト Contact	-

SMA-JJ

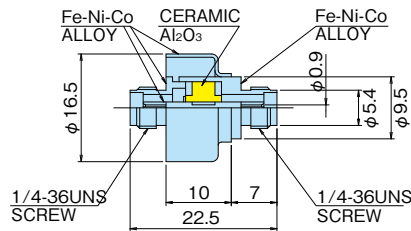

Part Number	17717
TYPE	-
許容電流値 Current [A max]	3
耐電圧 Voltage [V max]	D.C 1,000
抵抗 Impedance [Ω]	50
気密度 Leak rate [1.3xPa · m ³ /s]	10 ⁻¹⁰
* 絶縁抵抗 Insulation [Ω min.]	10 ⁹
* 高温温度 Max. Temp. [deg. C]	450
* 低温温度 Min. Temp. [deg. C]	-196
[Option] プラグ Plug	11SMA-50-3-7C
[Option] コンタクト Contact	-

SMA-JJ-F

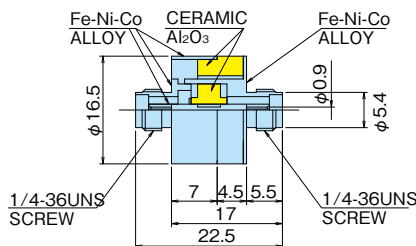

Part Number	87200
TYPE	Floating
許容電流値 Current [A max]	3
耐電圧 Voltage [V max]	D.C 1,000
抵抗 Impedance [Ω]	50
気密度 Leak rate [1.3xPa · m ³ /s]	10 ⁻¹⁰
* 絶縁抵抗 Insulation [Ω min.]	10 ⁹
* 高温温度 Max. Temp. [deg. C]	450
* 低温温度 Min. Temp. [deg. C]	-196
[Option] プラグ Plug	11SMA-50-3-7C
[Option] コンタクト Contact	-

* 弊社での基礎評価、判定基準に基づいた参考値です。特性値は使用状況により異なる場合があります。
 Note that these numbers are meant as reference only and are based on our basic evaluation and set criteria.
 The numbers may vary depending on the product's usage.

Coaxial Connectors

同軸端子

LEMO 社の LEMO 00 シリーズに嵌合する同軸端子です。
 Following Coaxial Connectors conform with LEMO 00series connectors which produced by LEMO.

LM-00R

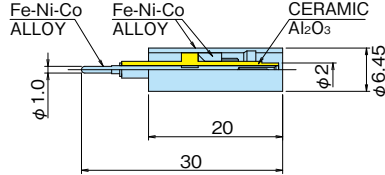

Part Number	17057
TYPE	-
許容電流値 Current [A max]	2
耐電圧 Voltage [V max]	D.C 1,000
抵抗 Impedance [Ω]	50
気密度 Leak rate [1.3xPa · m ³ /s]	10 ⁻¹⁰
* 絶縁抵抗 Insulation [Ω min.]	10 ⁹
* 高温温度 Max. Temp. [deg. C]	450
* 低温温度 Min. Temp. [deg. C]	-196
[Option] プラグ Plug	FFA00 250 CTAC31
コンタクト Contact	B1-No41.0001

LM-R-F

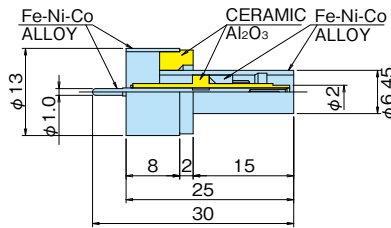

Part Number	86379
TYPE	Floating
許容電流値 Current [A max]	2
耐電圧 Voltage [V max]	D.C 1,000
抵抗 Impedance [Ω]	50
気密度 Leak rate [1.3xPa · m ³ /s]	10 ⁻¹⁰
* 絶縁抵抗 Insulation [Ω min.]	10 ⁹
* 高温温度 Max. Temp. [deg. C]	450
* 低温温度 Min. Temp. [deg. C]	-196
[Option] プラグ Plug	FFA00 250 CTAC31
コンタクト Contact	B1-No41.0001

LM-JJ

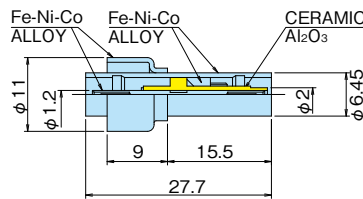

Part Number	18666
TYPE	-
許容電流値 Current [A max]	2
耐電圧 Voltage [V max]	D.C 1,000
抵抗 Impedance [Ω]	50
気密度 Leak rate [1.3xPa · m ³ /s]	10 ⁻¹⁰
* 絶縁抵抗 Insulation [Ω min.]	10 ⁹
* 高温温度 Max. Temp. [deg. C]	450
* 低温温度 Min. Temp. [deg. C]	-196
[Option] プラグ Plug	FFA00 250 CTAC31
コンタクト Contact	-

LM-JJ-F

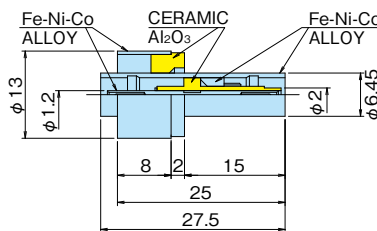

Part Number	86380
TYPE	Floating
許容電流値 Current [A max]	2
耐電圧 Voltage [V max]	D.C 1,000
抵抗 Impedance [Ω]	50
気密度 Leak rate [1.3xPa · m ³ /s]	10 ⁻¹⁰
* 絶縁抵抗 Insulation [Ω min.]	10 ⁹
* 高温温度 Max. Temp. [deg. C]	450
* 低温温度 Min. Temp. [deg. C]	-196
[Option] プラグ Plug	FFA00 250 CTAC31
コンタクト Contact	-

* 弊社での基礎評価、判定基準に基づいた参考値です。特性値は使用状況により異なる場合があります。
 Note that these numbers are meant as reference only and are based on our basic evaluation and set criteria.
 The numbers may vary depending on the product's usage.

Feedthroughs

電力、ヒーター、ランプなど大きな電流を使用するのに適しています。最高使用電圧・電流容量・スリーブ材質や釉薬有無の組み合わせから選択ください。また、ご希望に沿う条件のものが無い場合には、カスタムでの製作を致しますのでお問い合わせください。

Suitable for equipment that uses high current such as power, heaters and lamps. Please choose an appropriate combination of the maximum use voltage, current capacity, sleeve material, and glaze use. Kyocera is able to provide custom-made products other than the above; please feel free to contact us.

TYPE 表記方法:
Notation for TYPE

5KV-6-KV-KV-G

① ② ③ ④ ⑤

①耐電圧 voltage	[材質の表記] Material KV=Fe-Ni-Co Cu=O.F.H.C SUS=SUS
②電極径 Electrode Dia. (mm)	
③電極材質 Electrode Material	
④スリーブ材質 Sleeve Material	
⑤釉薬 Glaze	

■耐電圧 Voltage[D.C. MAX]

5KV

10KV

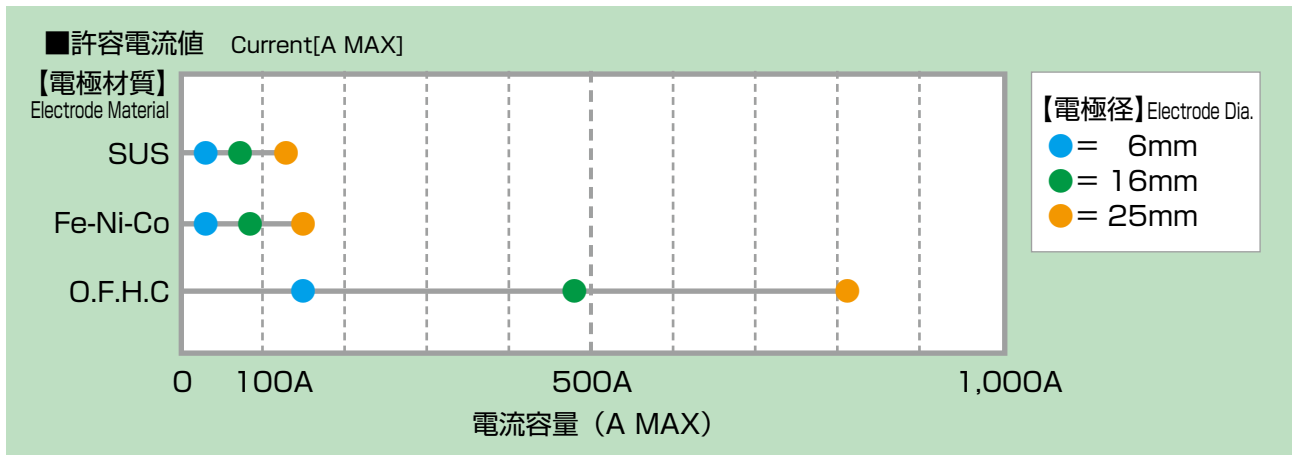

■オプションの選定 Option

- ・スリーブ材質: Fe-Ni-Co or SUS
Sleeve Material
- ・釉薬: Glaze

Feedthroughs

[5KV-6]

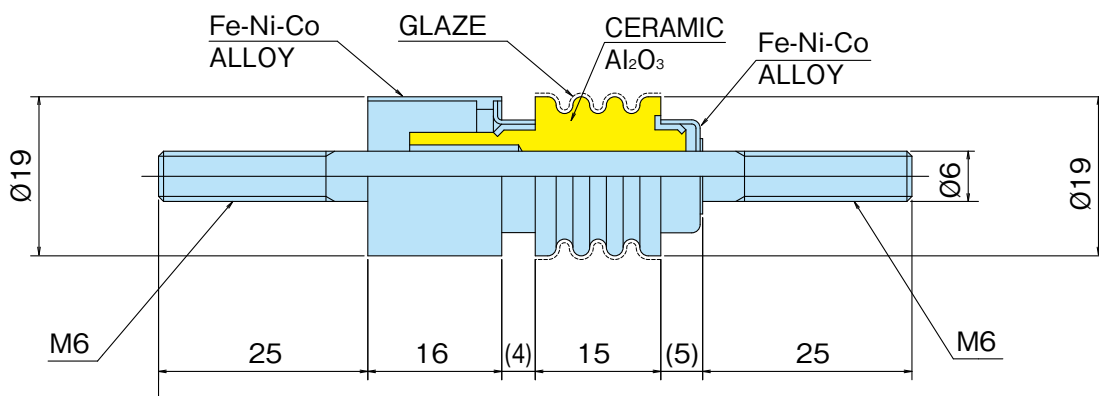

Part Number	TYPE	耐電圧 VOLTAGE [D.C MAX]	許容電流値 Current [A MAX]	*絶縁抵抗 Insulation [Ω at D.C500V]	気密性 Leak rate [1.3 × Pa·m ³ /s]	電極材質 Electrode	スリーブ材質 Sleeve	釉薬 Glaze
87000-1	5KV-6-SUS-SUS-G	5KV	22	10 ⁹	10 ⁻¹⁰	SUS	SUS	Glazed
87000-20	5KV-6-SUS-SUS	5KV	22	10 ⁹	10 ⁻¹⁰	SUS	SUS	—
87000-14	5KV-6-SUS-KV-G	5KV	22	10 ⁹	10 ⁻¹⁰	SUS	Fe-Ni-Co	Glazed
87000-17	5KV-6-SUS-KV	5KV	22	10 ⁹	10 ⁻¹⁰	SUS	Fe-Ni-Co	—
87000-11	5KV-6-KV-SUS-G	5KV	27	10 ⁹	10 ⁻¹⁰	Fe-Ni-Co	SUS	Glazed
87000-19	5KV-6-KV-SUS	5KV	27	10 ⁹	10 ⁻¹⁰	Fe-Ni-Co	SUS	—
87000-13	5KV-6-KV-KV-G	5KV	27	10 ⁹	10 ⁻¹⁰	Fe-Ni-Co	Fe-Ni-Co	Glazed
87000-16	5KV-6-KV-KV	5KV	27	10 ⁹	10 ⁻¹⁰	Fe-Ni-Co	Fe-Ni-Co	—
87000-60	5KV-6-Cu-SUS-G	5KV	145	10 ⁹	10 ⁻¹⁰	O.F.H.C	SUS	Glazed
87000-21	5KV-6-Cu-SUS	5KV	145	10 ⁹	10 ⁻¹⁰	O.F.H.C	SUS	—
87000-15	5KV-6-Cu-KV-G	5KV	145	10 ⁹	10 ⁻¹⁰	O.F.H.C	Fe-Ni-Co	Glazed
87000-18	5KV-6-Cu-KV	5KV	145	10 ⁹	10 ⁻¹⁰	O.F.H.C	Fe-Ni-Co	—

* 弊社での基礎評価、判定基準に基づいた参考値です。特性値は使用状況により異なる場合があります。
 Note that these numbers are meant as reference only and are based on our basic evaluation and set criteria.
 The numbers may vary depending on the product's usage.

Feedthroughs

[5KV-16]

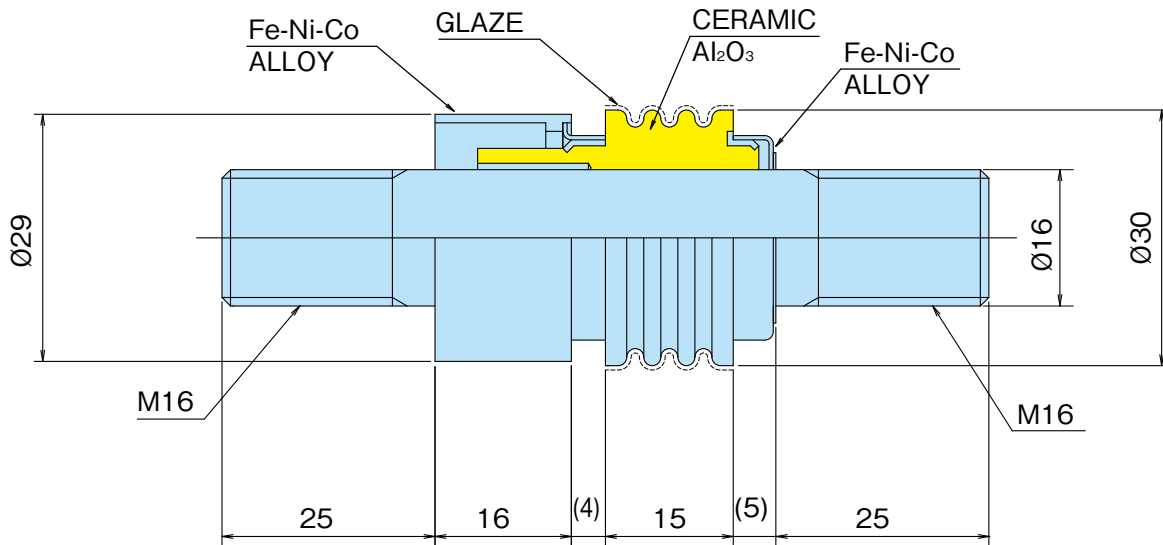

Part Number	TYPE	耐電圧 VOLTAGE [D.C MAX]	許容電流値 Current [A MAX]	*絶縁抵抗 Insulation [Ω at D.C500V]	気密性 Leak rate [1.3 × Pa·m ³ /s]	電極材質 Electrode	スリーブ材質 Sleeve	釉薬 Glaze
87000-26	5KV-16-SUS-SUS-G	5KV	73	10 ⁹	10 ⁻¹⁰	SUS	SUS	Glazed
87000-32	5KV-16-SUS-SUS	5KV	73	10 ⁹	10 ⁻¹⁰	SUS	SUS	—
87000-23	5KV-16-SUS-KV-G	5KV	73	10 ⁹	10 ⁻¹⁰	SUS	Fe-Ni-Co	Glazed
87000-29	5KV-16-SUS-KV	5KV	73	10 ⁹	10 ⁻¹⁰	SUS	Fe-Ni-Co	—
87000-25	5KV-16-KV-SUS-G	5KV	88	10 ⁹	10 ⁻¹⁰	Fe-Ni-Co	SUS	Glazed
87000-31	5KV-16-KV-SUS	5KV	88	10 ⁹	10 ⁻¹⁰	Fe-Ni-Co	SUS	—
87000-22	5KV-16-KV-KV-G	5KV	88	10 ⁹	10 ⁻¹⁰	Fe-Ni-Co	Fe-Ni-Co	Glazed
87000-28	5KV-16-KV-KV	5KV	88	10 ⁹	10 ⁻¹⁰	Fe-Ni-Co	Fe-Ni-Co	—
87000-27	5KV-16-Cu-SUS-G	5KV	476	10 ⁹	10 ⁻¹⁰	O.F.H.C	SUS	Glazed
87000-33	5KV-16-Cu-SUS	5KV	476	10 ⁹	10 ⁻¹⁰	O.F.H.C	SUS	—
87000-24	5KV-16-Cu-KV-G	5KV	476	10 ⁹	10 ⁻¹⁰	O.F.H.C	Fe-Ni-Co	Glazed
87000-30	5KV-16-Cu-KV	5KV	476	10 ⁹	10 ⁻¹⁰	O.F.H.C	Fe-Ni-Co	—

* 弊社での基礎評価、判定基準に基づいた参考値です。特性値は使用状況により異なる場合があります。
 Note that these numbers are meant as reference only and are based on our basic evaluation and set criteria.
 The numbers may vary depending on the product's usage.

Feedthroughs

[5KV-25]

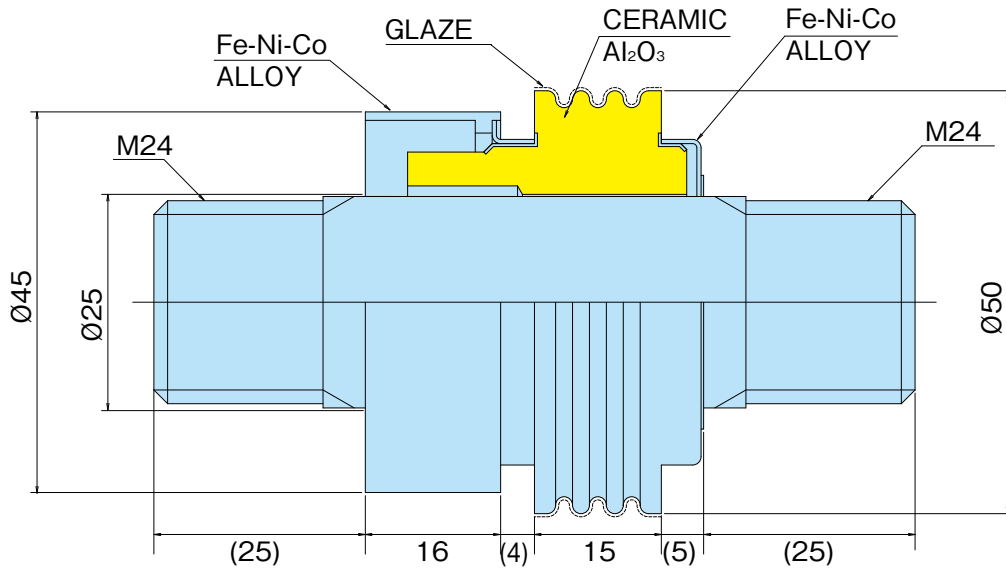

Part Number	TYPE	耐電圧 VOLTAGE [D.C MAX]	許容電流値 Current [A MAX]	*絶縁抵抗 Insulation [Ω at D.C500V]	気密性 Leak rate [1.3 × Pa·m ³ /s]	電極材質 Electrode	スリーブ材質 Sleeve	釉薬 Glaze
87000-38	5KV-25-SUS-SUS-G	5KV	124	10 ⁹	10 ⁻¹⁰	SUS	SUS	Glazed
87000-44	5KV-25-SUS-SUS	5KV	124	10 ⁹	10 ⁻¹⁰	SUS	SUS	—
87000-35	5KV-25-SUS-KV-G	5KV	124	10 ⁹	10 ⁻¹⁰	SUS	Fe-Ni-Co	Glazed
87000-41	5KV-25-SUS-KV	5KV	124	10 ⁹	10 ⁻¹⁰	SUS	Fe-Ni-Co	—
87000-37	5KV-25-KV-SUS-G	5KV	149	10 ⁹	10 ⁻¹⁰	Fe-Ni-Co	SUS	Glazed
87000-43	5KV-25-KV-SUS	5KV	149	10 ⁹	10 ⁻¹⁰	Fe-Ni-Co	SUS	—
87000-34	5KV-25-KV-KV-G	5KV	149	10 ⁹	10 ⁻¹⁰	Fe-Ni-Co	Fe-Ni-Co	Glazed
87000-40	5KV-25-KV-KV	5KV	149	10 ⁹	10 ⁻¹⁰	Fe-Ni-Co	Fe-Ni-Co	—
87000-39	5KV-25-Cu-SUS-G	5KV	808	10 ⁹	10 ⁻¹⁰	O.F.H.C	SUS	Glazed
87000-45	5KV-25-Cu-SUS	5KV	808	10 ⁹	10 ⁻¹⁰	O.F.H.C	SUS	—
87000-36	5KV-25-Cu-KV-G	5KV	808	10 ⁹	10 ⁻¹⁰	O.F.H.C	Fe-Ni-Co	Glazed
87000-42	5KV-25-Cu-KV	5KV	808	10 ⁹	10 ⁻¹⁰	O.F.H.C	Fe-Ni-Co	—

* 弊社での基礎評価、判定基準に基づいた参考値です。特性値は使用状況により異なる場合があります。
 Note that these numbers are meant as reference only and are based on our basic evaluation and set criteria.
 The numbers may vary depending on the product's usage.

Feedthroughs

[10KV-6]

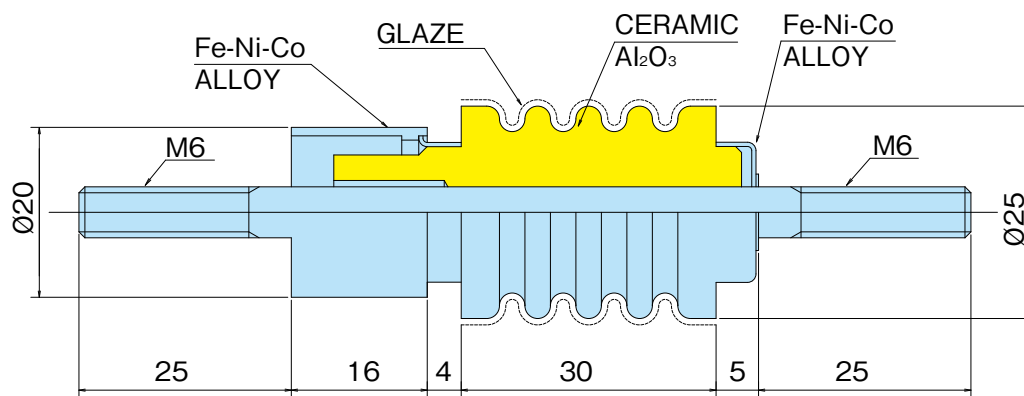

Part Number	TYPE	耐電圧 VOLTAGE [D.C MAX]	許容電流値 Current [A MAX]	*絶縁抵抗 Insulation [Ω at D.C500V]	気密性 Leak rate [1.3 × Pa·m ³ /s]	電極材質 Electrode	スリーブ材質 Sleeve	釉薬 Glaze
87000-7	10KV-6-SUS-SUS-G	10KV	22	10 ⁹	10 ⁻¹⁰	SUS	SUS	Glazed
87000-51	10KV-6-SUS-SUS	10KV	22	10 ⁹	10 ⁻¹⁰	SUS	SUS	—
87000-6	10KV-6-SUS-KV-G	10KV	22	10 ⁹	10 ⁻¹⁰	SUS	Fe-Ni-Co	Glazed
87000-48	10KV-6-SUS-KV	10KV	22	10 ⁹	10 ⁻¹⁰	SUS	Fe-Ni-Co	—
87000-46	10KV-6-KV-SUS-G	10KV	27	10 ⁹	10 ⁻¹⁰	Fe-Ni-Co	SUS	Glazed
87000-50	10KV-6-KV-SUS	10KV	27	10 ⁹	10 ⁻¹⁰	Fe-Ni-Co	SUS	—
87000-3	10KV-6-KV-KV-G	10KV	27	10 ⁹	10 ⁻¹⁰	Fe-Ni-Co	Fe-Ni-Co	Glazed
87000-47	10KV-6-KV-KV	10KV	27	10 ⁹	10 ⁻¹⁰	Fe-Ni-Co	Fe-Ni-Co	—
87000-2	10KV-6-Cu-SUS-G	10KV	145	10 ⁹	10 ⁻¹⁰	O.F.H.C	SUS	Glazed
87000-52	10KV-6-Cu-SUS	10KV	145	10 ⁹	10 ⁻¹⁰	O.F.H.C	SUS	—
87000-4	10KV-6-Cu-KV-G	10KV	145	10 ⁹	10 ⁻¹⁰	O.F.H.C	Fe-Ni-Co	Glazed
87000-49	10KV-6-Cu-KV	10KV	145	10 ⁹	10 ⁻¹⁰	O.F.H.C	Fe-Ni-Co	—

* 弊社での基礎評価、判定基準に基づいた参考値です。特性値は使用状況により異なる場合があります。
 Note that these numbers are meant as reference only and are based on our basic evaluation and set criteria.
 The numbers may vary depending on the product's usage.

Feedthroughs

[10KV-16]

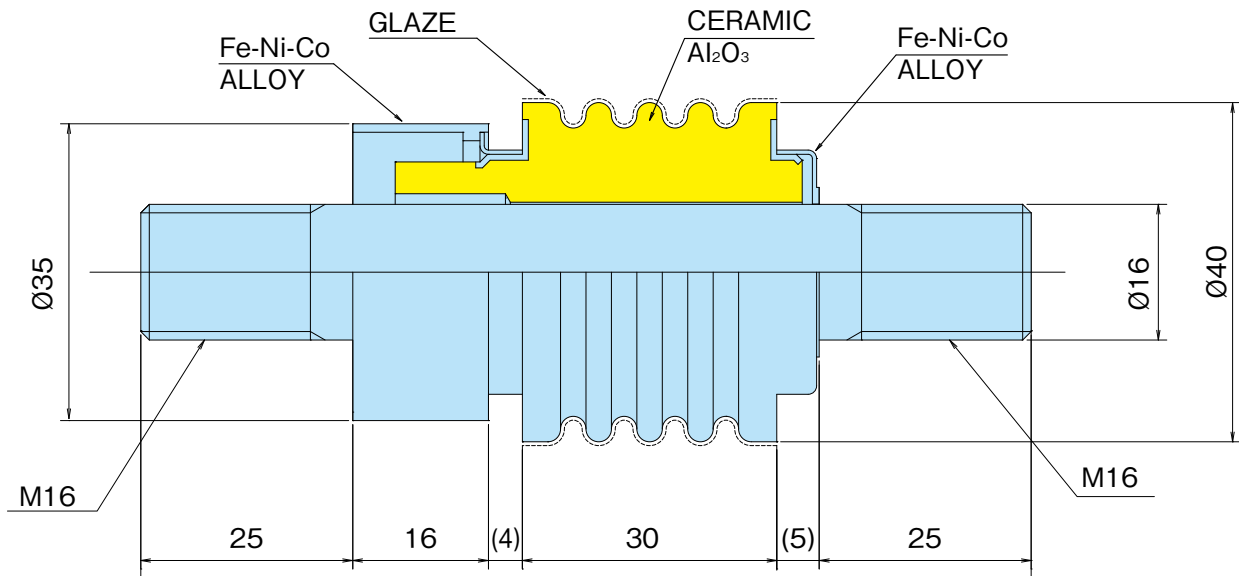

Part Number	TYPE	耐電圧 VOLTAGE [D.C MAX]	許容電流値 Current [A MAX]	*絶縁抵抗 Insulation [Ω at D.C500V]	気密性 Leak rate [1.3 × Pa·m³/s]	電極材質 Electrode	スリーブ材質 Sleeve	釉薬 Glaze
87000-5-06	10KV-16-SUS-SUS-G	10KV	73	10 ⁹	10 ⁻¹⁰	SUS	SUS	Glazed
87000-57	10KV-16-SUS-SUS	10KV	73	10 ⁹	10 ⁻¹⁰	SUS	SUS	—
87000-5-05	10KV-16-SUS-KV-G	10KV	73	10 ⁹	10 ⁻¹⁰	SUS	Fe-Ni-Co	Glazed
87000-54	10KV-16-SUS-KV	10KV	73	10 ⁹	10 ⁻¹⁰	SUS	Fe-Ni-Co	—
87000-5-02	10KV-16-KV-SUS-G	10KV	88	10 ⁹	10 ⁻¹⁰	Fe-Ni-Co	SUS	Glazed
87000-56	10KV-16-KV-SUS	10KV	88	10 ⁹	10 ⁻¹⁰	Fe-Ni-Co	SUS	—
87000-5-01	10KV-16-KV-KV-G	10KV	88	10 ⁹	10 ⁻¹⁰	Fe-Ni-Co	Fe-Ni-Co	Glazed
87000-53	10KV-16-KV-KV	10KV	88	10 ⁹	10 ⁻¹⁰	Fe-Ni-Co	Fe-Ni-Co	—
87000-5-04	10KV-16-Cu-SUS-G	10KV	476	10 ⁹	10 ⁻¹⁰	O.F.H.C	SUS	Glazed
87000-58	10KV-16-Cu-SUS	10KV	476	10 ⁹	10 ⁻¹⁰	O.F.H.C	SUS	—
87000-5-03	10KV-16-Cu-KV-G	10KV	476	10 ⁹	10 ⁻¹⁰	O.F.H.C	Fe-Ni-Co	Glazed
87000-55	10KV-16-Cu-KV	10KV	476	10 ⁹	10 ⁻¹⁰	O.F.H.C	Fe-Ni-Co	—

* 弊社での基礎評価、判定基準に基づいた参考値です。特性値は使用状況により異なる場合があります。
 Note that these numbers are meant as reference only and are based on our basic evaluation and set criteria.
 The numbers may vary depending on the product's usage.

Feedthroughs

[10KV-25]

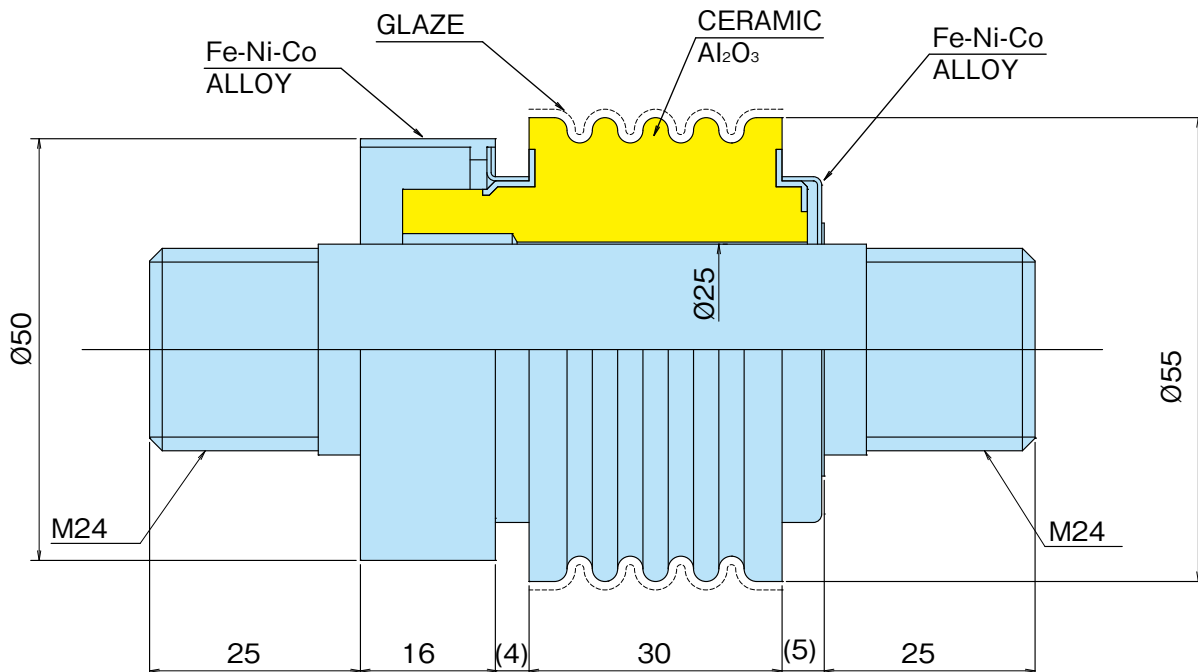

Part Number	TYPE	耐電圧 VOLTAGE [D.C MAX]	許容電流値 Current [A MAX]	*絶縁抵抗 Insulation [Ω at D.C500V]	気密性 Leak rate [1.3 × Pa·m³/s]	電極材質 Electrode	スリーブ材質 Sleeve	釉薬 Glaze
87000-63	10KV-25-SUS-SUS-G	10KV	124	10 ⁹	10 ⁻¹⁰	SUS	SUS	Glazed
87000-69	10KV-25-SUS-SUS	10KV	124	10 ⁹	10 ⁻¹⁰	SUS	SUS	—
87000-62	10KV-25-SUS-KV-G	10KV	124	10 ⁹	10 ⁻¹⁰	SUS	Fe-Ni-Co	Glazed
87000-68	10KV-25-SUS-KV	10KV	124	10 ⁹	10 ⁻¹⁰	SUS	Fe-Ni-Co	—
87000-61	10KV-25-KV-SUS-G	10KV	149	10 ⁹	10 ⁻¹⁰	Fe-Ni-Co	SUS	Glazed
87000-67	10KV-25-KV-SUS	10KV	149	10 ⁹	10 ⁻¹⁰	Fe-Ni-Co	SUS	—
87000-59	10KV-25-KV-KV-G	10KV	149	10 ⁹	10 ⁻¹⁰	Fe-Ni-Co	Fe-Ni-Co	Glazed
87000-66	10KV-25-KV-KV	10KV	149	10 ⁹	10 ⁻¹⁰	Fe-Ni-Co	Fe-Ni-Co	—
87000-65	10KV-25-Cu-SUS-G	10KV	808	10 ⁹	10 ⁻¹⁰	O.F.H.C	SUS	Glazed
87000-71	10KV-25-Cu-SUS	10KV	808	10 ⁹	10 ⁻¹⁰	O.F.H.C	SUS	—
87000-64	10KV-25-Cu-KV-G	10KV	808	10 ⁹	10 ⁻¹⁰	O.F.H.C	Fe-Ni-Co	Glazed
87000-70	10KV-25-Cu-KV	10KV	808	10 ⁹	10 ⁻¹⁰	O.F.H.C	Fe-Ni-Co	—

* 弊社での基礎評価、判定基準に基づいた参考値です。特性値は使用状況により異なる場合があります。
 Note that these numbers are meant as reference only and are based on our basic evaluation and set criteria.
 The numbers may vary depending on the product's usage.

Isolators

真空用の規格フランジに合わせた絶縁フランジです。
標準寸法その他、ご希望の電圧、用途に合わせたものが製造可能です。
Isolator flanges for vacuum application.
Standard sizes and custom made are available.

unit : mm

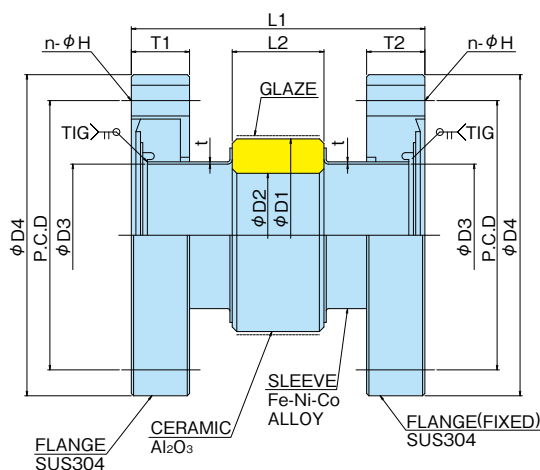

参考値：沿面耐電圧 DC600V/mm
AC400V/mm

No	PART NAME(品名)	Part Number	耐電圧 Voltage [V max]	*絶縁抵抗 Insulation [Qmin.]	気密度 Leak rate [1.3xPa·m ³ /s]	*高温温度 Max. Temp. [deg. C]	*低温温度 Min. Temp. [deg. C]
A	ISOLATORS No.A	90283-1	6,000	10 ⁹	10 ⁻¹⁰	450	-196
B	ISOLATORS No.B	90283-2	12,000				
C	ISOLATORS No.C	90283-3	12,000				
D	ISOLATORS No.D	90283-4	24,000				
E	ISOLATORS No.E	90283-5	12,000				
F	ISOLATORS No.F	90283-6	24,000				
G	ISOLATORS No.G	90283-7	12,000				
H	ISOLATORS No.H	90283-8	24,000				
I	ISOLATORS No.I	90283-9	12,000				
J	ISOLATORS No.J	90283-10	24,000				
K	ISOLATORS No.K	90283-11	12,000				
L	ISOLATORS No.L	90283-12	24,000				

No	φD1	φD2	φD3	φD4	L1	L2	T1	T2	P.C.D	φH	n	t
A	25	14	15.4	34	60	10	7.5	7.5	27	4.5	6	0.5
B	25	14	15.4	34	70	20	7.5	7.5	27	4.5	6	0.5
C	42	27	29	70	62	20	12.7	12.7	58.7	6.7	6	0.5
D	42	27	29	70	82	40	12.7	12.7	58.7	6.7	6	0.5
E	70	56	58.5	114	80	20	19	17.5	92.2	8.4	8	0.5
F	70	56	58.5	114	100	40	19	17.5	92.2	8.4	8	0.5
G	100	75	76.5	152	95	20	21	20	130.3	8.4	16	0.75
H	100	75	76.5	152	115	40	21	20	130.3	8.4	16	0.75
I	148	122	101.5	203	105	20	24	22	181.1	8.4	20	0.75
J	148	122	101.5	203	125	40	24	22	181.1	8.4	20	0.75
K	190	135	136	253	110	20	25	25	231.9	8.4	24	1.0
L	190	135	136	253	130	40	25	25	231.9	8.4	24	1.0

* 弊社での基礎評価、判定基準に基づいた参考値です。特性値は使用状況により異なる場合があります。
Note that these numbers are meant as reference only and are based on our basic evaluation and set criteria.
The numbers may vary depending on the product's usage.

Isolators with Bellows

真空用の規格フランジに合わせた絶縁フランジです。
 標準寸法その他、ご希望の電圧、用途に合わせたものが製造可能です。
 Isolator flanges for vacuum application.
 Standard sizes and custom made are available.

unit : mm

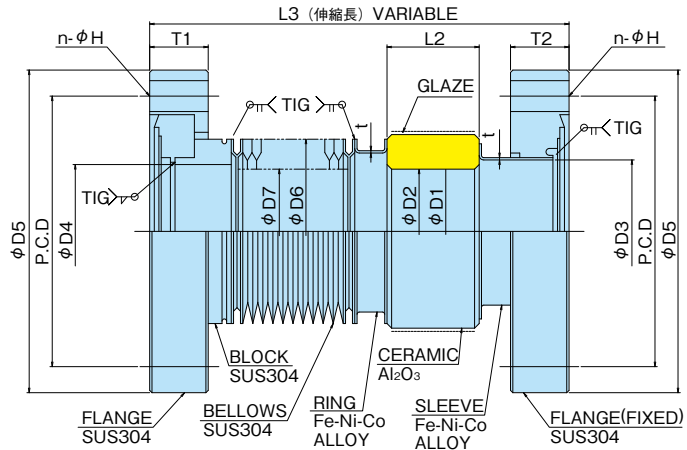

参考値 : 沿面耐電圧 DC600V/mm
 AC400V/mm

No	PART NAME(品名)	Part Number	No	T1	T2	P.C.D	H	n	t
A	ISOLATORS WITH BELLOWS No.A	90284-1	A	7.5	7.5	27	4.5	6	0.5
B	ISOLATORS WITH BELLOWS No.B	90284-2	B	7.5	7.5	27	4.5	6	0.5
C	ISOLATORS WITH BELLOWS No.C	90284-3	C	12.7	12.7	58.7	6.7	6	0.5
D	ISOLATORS WITH BELLOWS No.D	90284-4	D	12.7	12.7	58.7	6.7	6	0.5
E	ISOLATORS WITH BELLOWS No.E	90284-5	E	19	17.5	92.2	8.4	8	0.5
F	ISOLATORS WITH BELLOWS No.F	90284-6	F	19	17.5	92.2	8.4	8	0.5
G	ISOLATORS WITH BELLOWS No.G	90284-7	G	21	20	130.3	8.4	16	0.75
H	ISOLATORS WITH BELLOWS No.H	90284-8	H	21	20	130.3	8.4	16	0.75
I	ISOLATORS WITH BELLOWS No.I	90284-9	I	24	22	181.1	8.4	20	0.75
J	ISOLATORS WITH BELLOWS No.J	90284-10	J	24	22	181.1	8.4	20	0.75
K	ISOLATORS WITH BELLOWS No.K	90284-11	K	25	25	231.9	8.4	24	1.0
L	ISOLATORS WITH BELLOWS No.L	90284-12	L	25	25	231.9	8.4	24	1.0

No	φD1	φD2	φD3	φD4	φD5	φD6	φD7	L2	L3
A	25	14	15.4	14	34	26	12	10	63~71
B	25	14	15.4	14	34	26	12	20	71~79
C	42	27	29	31	70	40	27	20	88.5~96.5
D	42	27	29	31	70	40	27	40	108.5~116.5
E	70	56	58.5	60.5	114	80	60	20	100.5~108.5
F	70	56	58.5	60.5	114	80	60	40	120.5~128.5
G	100	75	76.5	79.5	152	100	75	20	105.5~113.5
H	100	75	76.5	79.5	152	100	75	40	125.5~133.5
I	148	122	101.5	104.5	203	162	132	20	118~126
J	148	122	101.5	104.5	203	162	132	40	138~147
K	190	135	136	140	253	185	135	20	117~125
L	190	135	136	140	253	185	135	40	137~145

No. A, B, E, F
 は内側からボルトが
 入りません。
 ナットの使用のみと
 なります。
 No. A, B, E, F
 apply Only nut no
 bolt from inside.

Sapphire Windows

単結晶サファイアを使った覗き窓です。真空用の規格フランジに合わせたサイズその他、耐圧用の窓の製作も行います。光学用の計測窓には、無反射コーティングを行うこともできます。

Single crystal sapphire is used. AR coating is option.

unit : mm

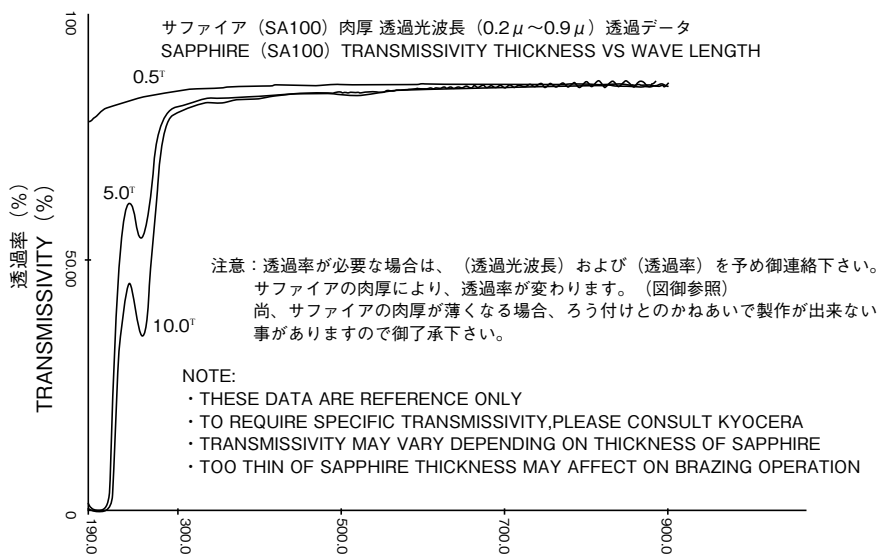
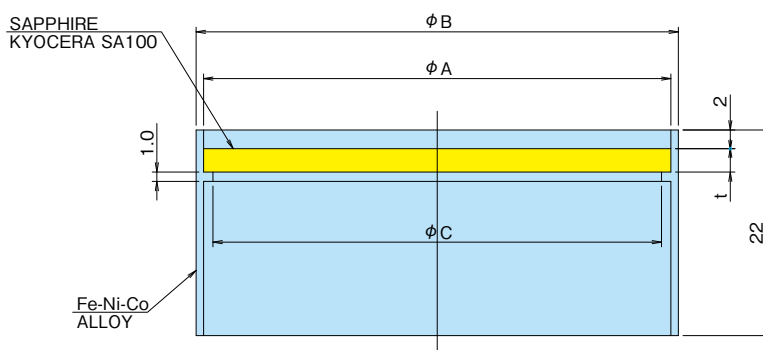

Part Number	PART NAME(φ) mm・名称	A	B	C	t
90167-1	SAPPHIRE WINDOWS φ20	20	21.6	18	2
90167-2	SAPPHIRE WINDOWS φ30	30	31.6	28	2
90167-3	SAPPHIRE WINDOWS φ35	35	36.6	33	2.5
90167-4	SAPPHIRE WINDOWS φ40	40	41.6	38	2.5
90167-5	SAPPHIRE WINDOWS φ50	50	51.6	48	2.5
90167-6	SAPPHIRE WINDOWS φ60	60	61.6	58	3
90167-7	SAPPHIRE WINDOWS φ70	70	71.6	68	3
90167-8	SAPPHIRE WINDOWS φ80	80	81.6	78	3
90167-9	SAPPHIRE WINDOWS φ100	100	101.6	98	4
90167-10	SAPPHIRE WINDOWS φ150	150	151.6	148	4

Sapphire Windows with Vacuum Flange

真空用フランジ（コンフラットフランジ）にサファイア窓を取りつけたものです。真空装置にこのまま取り付けて使用して頂けます。

Products for vacuum Flange (ConFlat Flange) assembled with sapphire windows.

They can be used by attaching them directly to vacuum equipment.

unit : mm

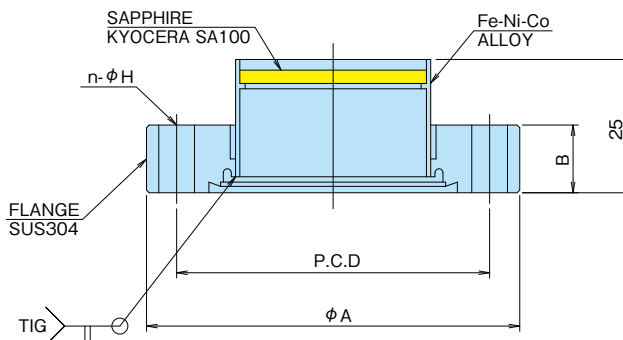

Part Number	PART NAME・名称	A	B	n	H	P.C.D
90170-1	70F SW35	70	12.7	6	6.7	58.7
90170-2	114F SW70	114	17.5	8	8.4	92.2
90170-3	152F SW100	152	20	16	8.4	130.3
90170-4	203F SW150	203	22	20	8.4	181.1

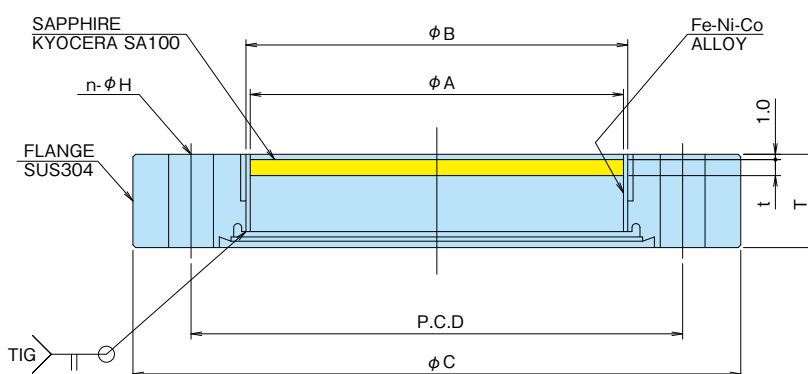

Part Number	PART NAME・名称	A	B	C	t	T	n	H	P.C.D
97111	70F SW35S	35	36.6	70	2.5	12.7	6	6.7	58.7
90173-1	114F SW70S	70	71.6	114	3	17.5	8	8.4	92.2
90173-2	152F SW100S	100	101.6	152	4	20	16	8.4	130.3
90173-3	203F SW150S	150	151.6	203	4	22	20	8.4	181.1

Introducing New Technology

D-sub セラミック真空気密端子（ロウ付け接合品）

Hermetic Subminiature D type Ceramic Feedthroughs

超高真空用途で使用可能なセラミックによる D-sub 真空気密端子です。
MIL-C-24308 に相当した製品が製作可能です。

Subminiature D type Ceramic Feedthroughs have good hermetic properties for Ultra High Vacuum Application.
The Feedthroughs are equivalent to MIL-C-24308.

9 PIN



15 PIN



25 PIN

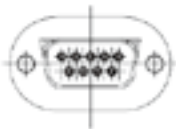
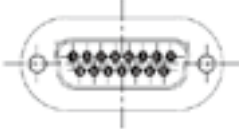
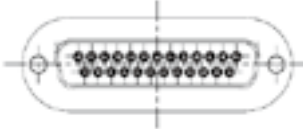

■ 特性表 Characteristics

項目 Items	単位 Unit	PIN Type		
		9 PIN	15 PIN	25 PIN
大きさ Size (W・H・L)	mm	 31.3 x 18.3 x 22.0	 39.7 x 18.3 x 22.0	 53.3 x 18.3 x 22.0
許容電流値 Current	A/Pin max.	3		
耐電圧 Voltage	V max	D.C. 300		
気密度 Leak Rate	1.3xPa·m ³ /s	10 ⁻¹⁰		
*絶縁抵抗 Insulation	Ω min.	10 ⁹		

* 弊社での基礎評価、判定基準に基づいた参考値です。特性値は使用状況により異なる場合があります。
Note that these numbers are meant as reference only and are based on our basic evaluation and set criteria.
The numbers may vary depending on the product's usage.

Introducing New Technology

液体水素対応ロウ付け接合品

Hermetic Connector for Liquid Hydrogen Environment

水素社会実現に向け、液体水素環境 (-253℃) で使用可能な製品ニーズが高まると予想されています。京セラは、宇宙航空研究開発機構 (JAXA) 様と共同研究を実施。液体水素環境下で使用可能であると確認しました。

It is anticipated that there will be a growing demand for liquid hydrogen in the future toward the realization of a hydrogen society. Through joint research with the Japan Aerospace Exploration Agency (JAXA), we have confirmed that several types of products can be used in a liquid hydrogen environment.

特長

Features

- 極低温の厳しい温度サイクル試験に合格

Passed the temperature cycle test under the severe condition of cryogenic temperature.

用途

Application

- 液体水素運搬船のポンプに使用される電流導入端子

Feedthroughs for liquid hydrogen carrier pump.

- 宇宙ロケット搭載タンクや地上設備用タンクに使用されるセンサ用気密端子など

Feedthroughs for sensors used in space rocket tanks and ground equipment tanks etc.

■ SMA タイプ



© 宇宙航空研究開発機構 (JAXA)

■ 常圧水素環境下での耐久性確認

Temperature cycle test conditions under atmospheric pressure and hydrogen environment.

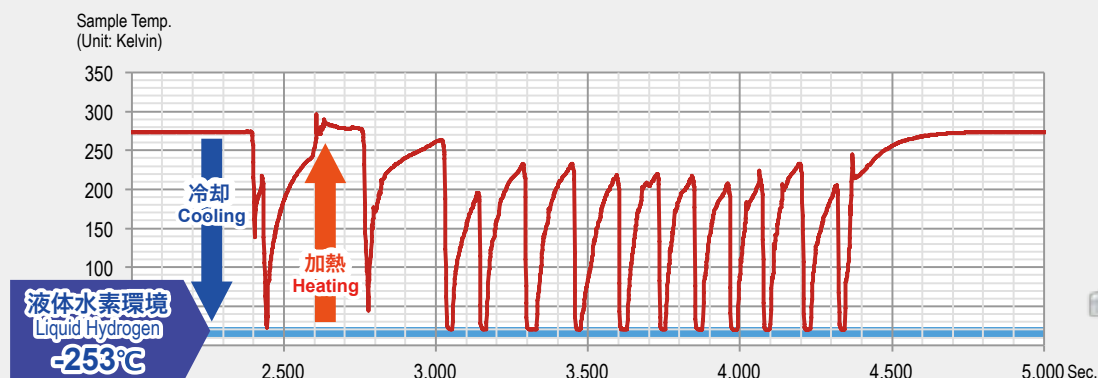

急速膨張試験 (提供: JAXA)

Rapid temperature cycle test (Provision of data: JAXA)

* カスタム設計となりますので、随時お問い合わせください。

All hermetic connectors for liquid hydrogen are custom designed.

Please contact us for details.

Introducing New Technology

非磁性ロウ付け接合品

Non-magnetic Feedthrough

京セラは、銅 (Cu) やチタン (Ti) など非磁性金属とのロウ付け技術により、非磁性の超高真空気密端子の製作が可能です。この気密端子は、超電導・加速器など強い磁界の分野で広く利用されており、磁界への影響の抑制に貢献しております。

Kyocera's brazing technology with non-magnetic metals such as copper (Cu) and titanium (Ti) enables the production of non-magnetic ultra-high vacuum feedthroughs. These feedthroughs are widely used in the strong magnetic fields such as superconductivity and accelerators, and contribute to reducing the influence on magnetic fields.

■ 非磁性金具への変更例 [標準品 N-R]

Example of change to non-magnetic metal fittings

Electrode: [非磁性金具] 銅(Cu)、チタン(Ti)など
Non-magnetic metal fittings: Cu or Ti, etc.

Sleeve: [非磁性金具] チタン(Ti)など
Non-magnetic metal fittings: Ti, etc.

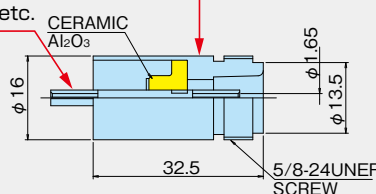

* 非磁性金属については、製作できる組み合わせがあります。詳細についてはお問合せ下さい。
For non-magnetic metals, various combinations can be made. Please contact us for details.

アルミニウム金具とのロウ付け接合品

Feedthrough with Aluminum Metal Fittings

京セラは、耐腐食性・熱伝導率に優れたアルミニウム金具へのロウ付け技術を有しております。京セラ標準品をアルミニウム金具へ変更可能です。

Aluminum metal fittings with excellent corrosion resistance and thermal conductivity can also be brazed. The metal parts of our standard products can be changed to aluminum metal fittings.

■ アルミニウム金具への変更例 [標準品 BNC-R]

Example of change to aluminum metal fittings

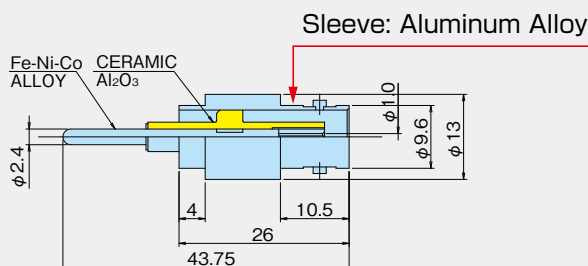

* 製作できる組み合わせがあります。詳細についてはお問合せ下さい。
Various combinations can be made. Please contact us for details.

Introducing New Technology

高周波窓用セラミックス

RF Window Ceramics

MHz、GHzといった高周波帯域のRF窓用部材には、誘電損失の低いセラミック材料が使用されています。京セラでは、従来のセラミック材料に加え、より低い誘電損失の材料 (AO479B, SN287A) をラインナップし、幅広い周波数帯でのご要求にお応え致します。

At the high-frequency field in the MHz and GHz bands, ceramics with low dielectric loss characteristics are used in RF window components. In addition to conventional ceramic materials, Kyocera also has materials with lower dielectric loss (AO479B, SN287A).

特長

Features

- 用途、要求特性に応じた材料提案
Material proposals according to usage and required characteristics

用途

Application

- 高周波帯域のRF窓用部材
RF window components at the high-frequency field

材料特性表 Material Characteristics

項目 Item	単位 Unit	アルミナ Al ₂ O ₃				窒化ケイ素 Si ₃ N ₄	
		AO4730	AO4760	AO4790	AO479B	SN287A	
		Conventional materials			Lower dielectric loss materials		
熱伝導率 (20℃) Thermal Conductivity	W/mK	18	26	29	29	59	
比誘電率 Dielectric Constant	-	9.0	9.4	9.9	9.9	7.8-8.0	
誘電正接 ^{*1} Dielectric Loss Angle	1MHz	x10 ⁻⁴	6	4	2	1	-
	1GHz	x10 ⁻⁴	19	17	15	<10	-
	3.2GHz 付近	x10 ⁻⁴	7.6	5.5	1.5	0.3	0.4-0.6
	8.5GHz 付近	x10 ⁻⁴	10	6.4	2	0.4	-
	10GHz 付近	x10 ⁻⁴	-	-	-	-	0.7-0.9
	30GHz 付近	x10 ⁻⁴	-	-	-	-	1.0-1.2
三点曲げ強さ Flexural Strength	MPa	340	350	310	300	730	

〈数値は比較・参考値(Reference Data)〉

*1 誘電正接測定方法：1GHz: 高周波電流電圧法 / 3.2GHz 付近：誘電体装荷空洞共振法 / 8.5GHz 付近：円柱共振法

Dielectric loss measurement method: 1GHz: High-frequency current-voltage method / around 3.2GHz: Dielectric loaded cavity resonance method around 8.5GHz: Cylindrical resonance method



円板 Disc Type



ドーナツ形状 Doughnut Type



金具ロウ付け Metal Brazed Type

Introducing New Technology

高沿面耐電圧アルミナ材料 (AH100A)

High Voltage-resistant Alumina Ceramic

従来より、耐電圧性能が高いアルミナセラミックスは、高電圧装置に広く使用されています。京セラは、さらに沿面耐電圧特性を向上させた新材料“AH100A”を開発致しました。AH100Aは、従来材料と比較して、1.6倍の沿面耐電圧、1.2倍の貫通耐電圧の特性を有し、高電圧のコンディショニング時間の削減や、端子の小型化が可能となります。

Alumina is widely used in high-voltage equipment because of its high resistance to voltage. AH100A has a creepage withstand voltage 1.6 times higher and a penetration withstand voltage 1.2 times higher than those of conventional Kyocera alumina materials in vacuum. It also reduces high-voltage conditioning time. Because of these advantages, in some cases we have reduced the size of the product by 50%.

特長

Features

- 真空中の沿面耐電圧、及び貫通耐電圧性能を大幅に向上
Improvement of dielectric strength / creeping voltage resistance in vacuum atmosphere
- 高電圧コンディショニング時間大幅短縮
Conditioning time reduction at high voltage operation
- 従来比 50% の小型化を実現*
50% downsizing from conventional alumina* (*京セラ試算 based on Kyocera simulation)



■ 材料特性表、及び測定データ比較

Material Characteristics & Measurement Comparison

項目 Items		単位 Unit	AO4790	AH100A
電気的特性 Electrical Characteristics	到達電界強度 Reached Electric Field Strength	MV/m	8.4 (ave.)	14.1 (ave.)
	貫通耐電圧 Penetration Withstand Voltage	MV/m	19	24
	体積固有抵抗 Volume Resistivity	$\Omega \cdot \text{cm}$	$\geq 1 \times 10^{14}$	$\geq 1 \times 10^{14}$
	比誘電率 (1MHz) Dielectric Constant	-	9.9	10.2
	誘電正接 (1MHz) Dielectric Loss Angle	-	2×10^{-4}	$< 1 \times 10^{-4}$
機械的特性 Mechanical Characteristics	平均強度 ASTM D2442 TYPE3 Average Strength	MPa	310	330
	ヤング率 Young's Modulus of Elasticity	GPa	360	380
	ポアソン比 Poisson's Ratio	-	0.23	0.25
	破壊靱性 Fracture Toughness	$\text{MPa} \cdot \text{m}^{1/2}$	3~4	5
熱的特性 Thermal Characteristics	熱伝導率 Thermal Conductivity	W/mK	29	24
	熱膨張係数 (RT-800°C) Coefficient of Thermal Expansion	ppm/°C	8.0	8.2

< 数値は比較・参考値 (Reference Data) >

■ 小型化デザインのイメージ

Design Image of Size Reduction



■ コンディショニング時間

Conditioning Time

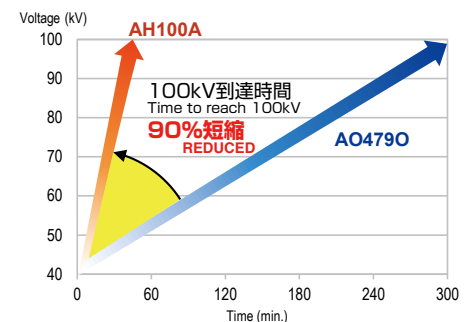

測定条件: 圧力 10⁻³Pa 以下
昇電圧 1kV/mm
フラッシュオーバーが起きると、OVから再昇電圧
Measuring: Pressure 10⁻³Pa
Conditions: Voltage Increase 1kV/min.
Restarted from OV every time flashover voltage is observed

Custom-designed Ceramic Chambers

unit : mm



by courtesy of Pohang University of Science and Technology



by courtesy of Pohang University of Science and Technology



Application: Kicker Magnet Beam

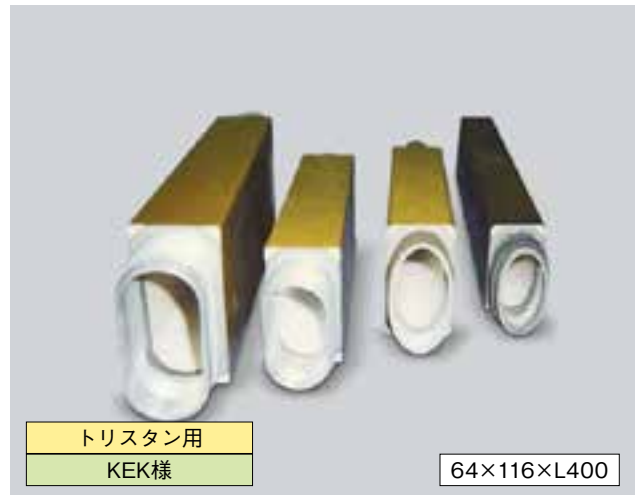

by courtesy of High Energy Accelerator Research Organization
Application: TRISTAN

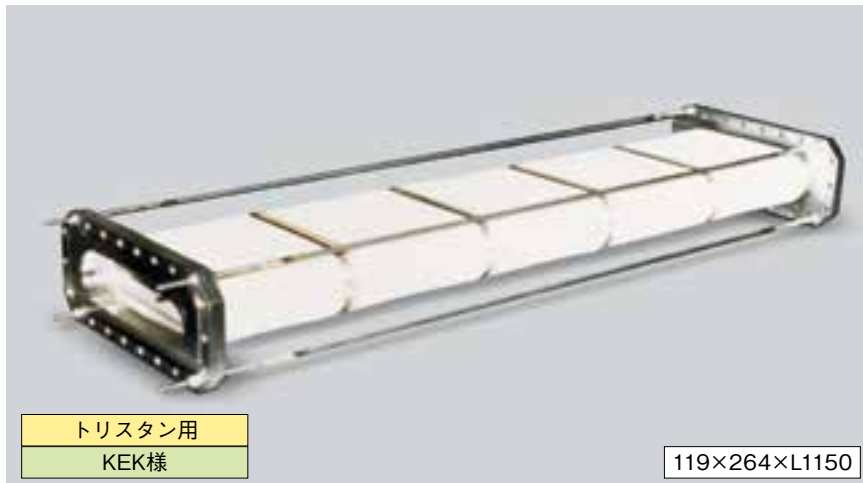

by courtesy of High Energy Accelerator Research Organization
Application: TRISTAN

Custom-designed Ceramic Chambers

unit : mm



KEK様

90×110×520

by courtesy of High Energy Accelerator Research Organization



KEK様

90×100×1500

by courtesy of High Energy Accelerator Research Organization

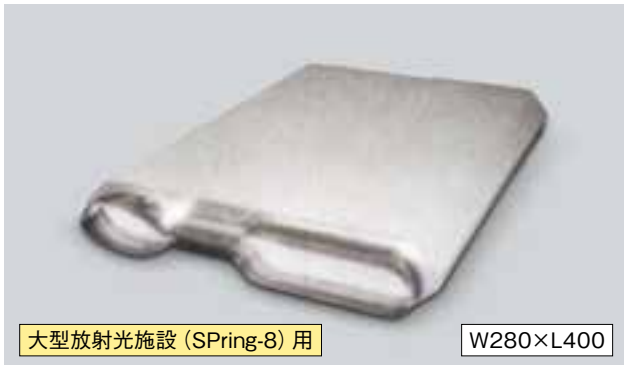

大型放射光施設 (SPring-8) 用

W280×L400

Application: SPring-8



LHC用
CERN様

□70×L1580

by courtesy of European Organization for Nuclear Research (CERN)
Application: Large Hadron Collider (LHC)



重粒子線ガン治療装置用
三菱電機株式会社様

φ90×L1150

by courtesy of Mitsubishi Electric Corporation
Application: Heavy Particle Radiotherapy

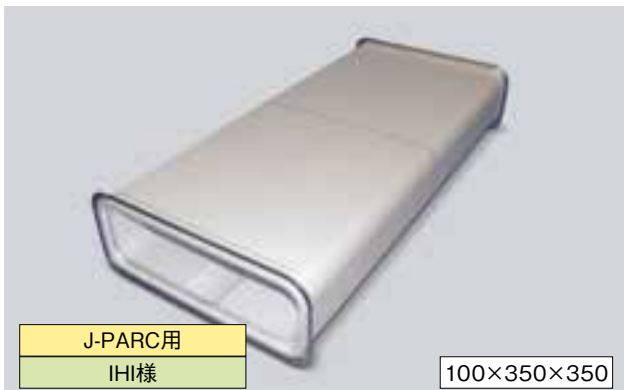

J-PARC用
IHI様

100×350×350

by courtesy of Ishikawajima-Harima Heavy Industries Co.,Ltd
Application: J-PARC

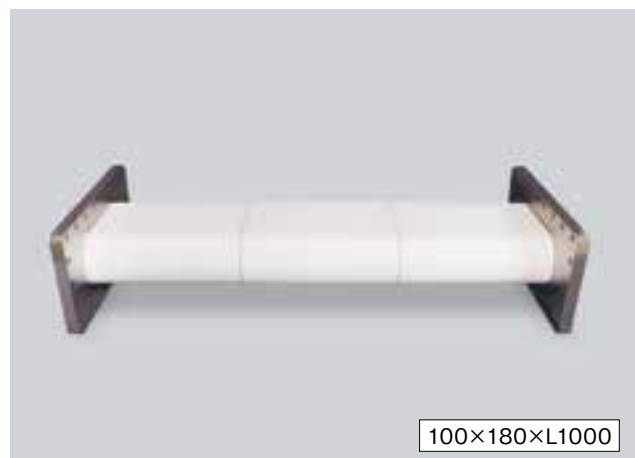

100×180×L1000

Custom-designed Isolator Flanges

unit : mm



LHD用
NIFS様

φ450×L580

by courtesy of National Institute for Fusion Science
Application: Large Helical Device



φ120



LHD用
NIFS様

φ450×L350

by courtesy of National Institute for Fusion Science
Applicaton: Large Helical Device



JT60用矩形絶縁フランジ
日本原子力研究開発機構様

500×500×L70

by courtesy of Japan Atomic Energy Agency
Applicaton: JT-60



φ540×L70

Custom-designed Accelerator Tubes

unit : mm



by courtesy of Japan Atomic Energy Agency
Application: Electron Gun



by courtesy of Tsukuba University



by courtesy of Advanced Research Laboratory, Hitachi, Ltd.
Application: Super High Voltage Electron Microscope

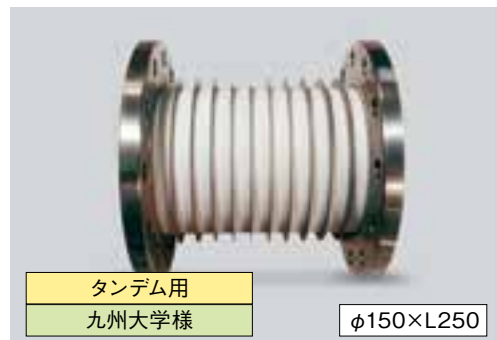

by courtesy of Kyushu University
Application: Tandem Accelerator



by courtesy of Hitachi, Ltd.
Application: Electron Microscope

Custom-designed Sapphire and Silicon Nitride Windows

unit : mm



LHD用
NIFS様

by courtesy of National Institute for Fusion Science
Application: Large Helical Device

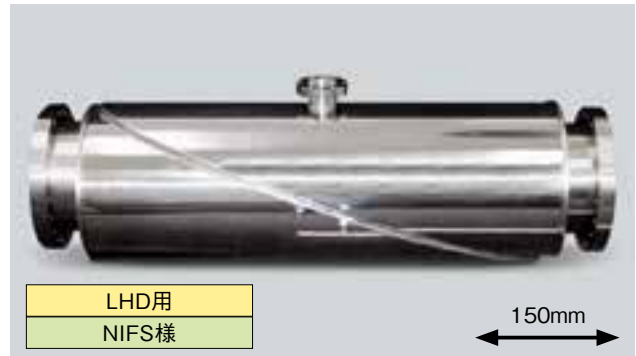

LHD用
NIFS様

150mm

by courtesy of National Institute for Fusion Science
Application: Large Helical Device

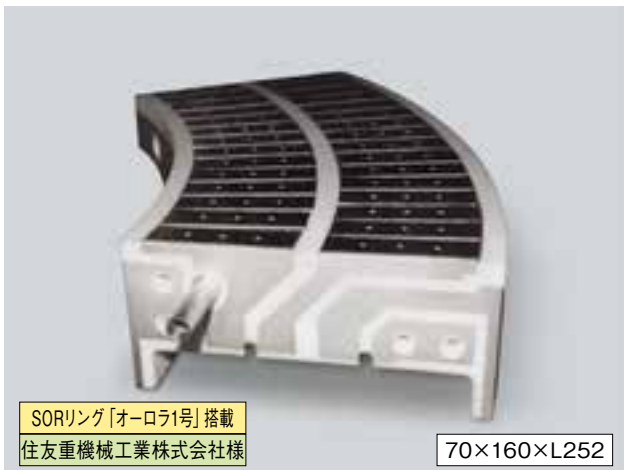

SORリング「オーロラ1号」搭載
住友重機械工業株式会社様

70×160×L252

by courtesy of Sumitomo Heavy Industries, Ltd.
Application: SORring "AURORA"



LHD用
NIFS様

φ180

by courtesy of National Institute for Fusion Science
Application: Large Helical Device



TRIAM-1M用SA窓
九州大学様

114×185×t7

by courtesy of Kyushu University
Application: TRIAM-1M

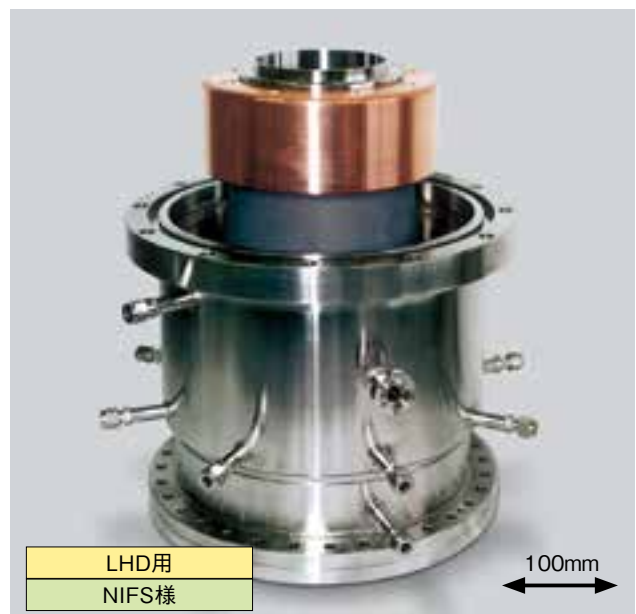

LHD用
NIFS様

100mm

by courtesy of National Institute for Fusion Science
Application: Large Helical Device

Custom-designed Beam Feedthroughs

unit : mm

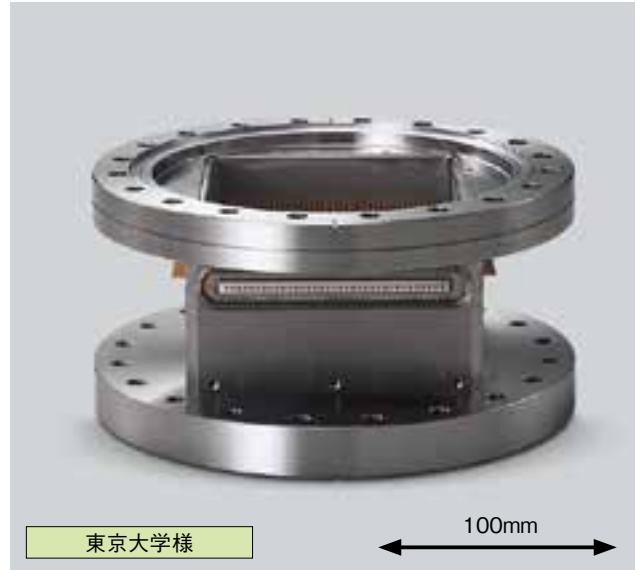

by courtesy of University of Tokyo



by courtesy of High Energy Accelerator Research Organization

Custom-designed Ion Source Feedthroughs

unit : mm



Custom-designed Feedthroughs

unit : mm



by courtesy of High Energy Accelerator Research Organization
Application : S-KEKB



100KV Feedthrough



Custom-designed Feedthroughs and Isolators

unit : mm



電子線装置用

$\phi 415 \times \phi 335 \times L220$

Application: Electron Beam Processing System



電子線装置用

$\phi 330 \times \phi 250 \times \phi 245 \times \phi 165 \times L220$

Application: Electron Beam Processing System

セラミックスの特性表

Characteristics Of Ceramics

Material Item		ALUMINA (Al ₂ O ₃)						SILICON NITRIDE (Si ₃ N ₄)	SINGLE CRYSTAL SAPPHIRE (Al ₂ O ₃)			
Kyocera No.	Conventional	A459	A473	A476	A479	A479S	A479M	SN220	SA100			
	New	AO459K	AO473O	AO476O	AO479O	AO479S	AO479M	SN220O	SA100			
Appearance		Dense	Dense	Dense	Dense	Dense	Dense	Dense	Dense			
Color		Russet	White	White	White	Ivory	Ivory	Black	Transparent			
Content (%)		89	92	96	99	99.5	99.5	-	99.99			
Main Characteristics		High Mechanical Strength, High Temperature Resistance, High Frequency Insulation, High Chemical Resistance						High Temperature Strength Wear Resistant Excellent Thermal Shock Resistance Light Weight	High Mechanical Strength High Heat Resistance High Chemical Resistance High Electric Insulation Resistance			
		Good for Metallizing	Good for Metallizing Mechanically Strong	Good Surface Smoothness	Hard and Chemically Stable	Hard and Chemically Stable Fine Grain Strong and Smooth	High Chemical Resistance					
Main Applications		Magnetron	IC Multi Layer Packages Electrontube Housing	Hybrid IC Substrates	Heat. Corrosion And Wear Resistant Parts	Pump Shafts	Wear Resistant Parts Chemically Resistant Parts Semiconductor Processing Equipment Parts	Internal Combustion Engine Parts Molten Metal Parts Gas Turbine Parts Metal Forming Tool	SOS Substrate Window for High Temperature High Pressure Equipment Construction Parts for Scientific Equipment			
Density (*1)	g/cm ³	JISR 1634	3.6	3.6	3.7	3.8	3.9	3.9	3.2	3.97		
Water Absorption	%	JISR 1634	0	0	0	0	0	0	0	0		
Mechanical Characteristics	Vickers Hardness HV9.807N	(GPa) JISR 1610	12.1	12.3	13.7	15.2	16.0	15.7	13.9	Surface a	22.5	
	Flexural Strength 3 P.B.	MPa JISR 1601	310	340	350	310	360	370	610	Surface a	690	
	Compressive Strength	MPa JISR 1608	-	2,300	-	2,160	2,350	-	3,820	2,940		
	Young's Modulus Of Elasticity	GPa JISR 1602	280	280	320	360	370	370	290	470		
	Poisson's Ratio	-	0.23	0.23	0.23	0.23	0.23	0.23	0.28	-		
	Fracture Toughness (SEPB)	MPam ^{1/2} JISR 1607	-	-	-	3~4	4	-	5	-		
Thermal Characteristics	Coefficient Of Linear Thermal Expansion	40~400°C	$\times 10^{-6}$ JISR 1618	7.0	6.9	7.2	7.2	7.2	7.2	2.6	Surface a	7.7
		40~800°C	JISR 1618	7.9	7.8	7.9	8.0	8.0	8.0	3.2	Surface a	7.0
	Thermal Conductivity 20°C	W/(m·K) JISR 1611	14	18	24	29	32	32	20	41		
	Specific Heat Capacity	J/(g·K) JISR 1611	0.75	0.78	0.78	0.79	0.78	0.78	0.66	0.75		
Thermal Shock (Put in Water, Temperature Difference Method)	°C JISR 1648	-	200	200	200	250	-	550	-			
Electrical Characteristics	Dielectric Strength	KV/mm	15	16	15	15	15	15	10	48		
		Volume Resistivity	20°C	>10 ¹⁴	>10 ¹⁴	>10 ¹⁴	>10 ¹⁴	>10 ¹⁴	>10 ¹⁴	>10 ¹⁴	>10 ¹⁴	
			300°C	10 ¹⁰	10 ¹²	10 ¹⁰	10 ¹⁰	10 ¹³	10 ¹³	10 ¹²	-	
	500°C	10 ⁸	10 ¹⁰	10 ⁸	10 ⁸	10 ¹⁰	10 ¹⁰	10 ¹⁰	10 ¹¹			
	Dielectric(1MHz) Constant	-	8.8	9.0	9.4	9.9	9.9	9.9	-	Parallel to Axis c	11.5	
	Dielectric(1MHz) Loss Angle	($\times 10^{-4}$)	6	6	4	2	1	1	-	Vertical to Axis c	9.3	
Loss Factor	($\times 10^{-4}$)	52	54	38	20	10	10	-	-			
Chemical Characteristics	Nitric Acid (60%) 90°C,24H	WTLoss mg/cm ²	-	0.32	-	0.10	0.07	-	1.00	≒0.00		
	Sulphuric Acid (95%) 95°C,24H		-	0.65	-	0.33	0.25	-	0.40	≒0.00		
	Caustic Soda (30%) 80°C,24H		-	0.91	-	0.26	0.05	-	0.36	≒0.00		

※これらの値はテストピースの測定による参考値です。特性値は製品の形状や使用条件により異なる場合があります。

※The values are typical material properties and may vary according to products configuration and manufacturing process. For more details, please feel free to contact us.

(注1) 密度は見掛密度、かさ密度、共に記載の値となります。

*1: All values for apparent density and bulk density are the same,

Precision Shaping and Machining

形状と加工精度

京セラは、独特のセラミックス精密機械加工技術により、原料から成形された生素材を切削加工、あるいは焼成後に研削、ラッピング加工を行い、要求された複雑な形状をしかも高精度に加工しています。

このようにして加工された京セラのセラミックス機械加工製品は、超高精度を要求される OA 機器の摺動部品をはじめとして、一般構造用部材、精密治工具、電磁ならびに化学薬品中で摺動する耐摩耗、耐薬品部品等に素晴らしい性能を発揮しています。

Using Kyocera's unique ceramic precision machining technology, the formed material is cut, ground and lapped after sintering to the required complex shapes with high precision. These products are used for their unrivaled performance in OA sliding parts with ultrahigh precision, general structural members, precision jigs and tools, and also in wear and chemical resistant parts sliding in electromagnetic fields and chemical solutions.

機械加工による寸法精度 Dimensional Precision Achieved by Machining

セラミックスに金属部品と同様な寸法精度の加工が要求される場合、下表のような公差まで加工しています。形状、寸法等、表で適用できない範囲は別途ご相談ください。

When dimensional precision equivalent to that for metal parts is required for machined ceramics, Kyocera can achieve the tolerances shown in the table below. If greater tolerances in shapes or dimensions are required, please contact us.

■加工寸法精度 (指示なき単位はmm) Machining Dimensional Precision (data are in mm unless otherwise specified)

①セラミックブロックおよび板類の研磨品 Ground ceramic blocks and plates

項目 Parameter	公差 Tolerance 大きさ Dimension	
	普通公差 Standard Tolerance	普通公差 Standard Tolerance
平行度 Parallelism	ϕ (SQ) 5~ ϕ (SQ) 30	ϕ (SQ) 30以上
平坦度 Flatness	0.01	0.03
表面粗さ Surface Roughness	1.5 μ Ra	1.5 μ Ra
鏡面研磨 Mirror Polishing	0.2 μ Ra	

②丸棒、角棒 Round and Square Bars ϕ 100 (SQ100) × 100L

項目 Parameter	公差 Tolerance Standard Tolerance
真円度 Roundness	0.01
直角度 Perpendicularity	0.01 (30')
真直度 Straightness	0.05/100
表面粗さ Surface Roughness	1.5 μ Ra

■精密加工品 Precision Machined Products

京セラ独自の加工法により、さらに精密な加工も可能です。精密加工の精度は形状、材質に左右されるため、特に実施例を下表に示します。

Ultra-precision is possible with Kyocera's unique techniques. Precision machining is affected by the shape and material. Some practical applications are shown in the table below.

加工例 Example of Machining	項目 Parameter	寸法 Dimensions	材質 Material	寸法公差 Dimensional Tolerance (μ m)	真円度 Roundness (μ m)	真直度 Perpendicularity Straightness (μ m)	表面粗さ Surface Roughness (μ Ra)
内径加工例 Inner Diameter		ϕ 6×L20	AO479S	±3	0.3	0.3	0.2
		ϕ 30×L20	AO479O	±3	0.3	0.3	0.3
外径加工例 Outer Diameter		ϕ 4×L20	AO479O	±1	0.3	0.3	0.3
		ϕ 40×L30	AO479S	±1	0.3	0.3	0.3
板状品加工例 Plate		ϕ 40× T5	AO479S	±1	平行度 1	平行度 1	0.2
		ϕ 100× T5	AO479O	±1	平行度 0.3	平行度 1	0.1

■表面粗さ (アルミナの例) Surface Roughness (Alumina)

①無研磨 As fired (3 μ Ra)



②研削 Ground (1 μ Ra)



③ラッピング Lapped (0.4 μ Ra)



④ポリシング Polished (0.2 μ Ra or less)



■真円度測定データ Roundness Measurement

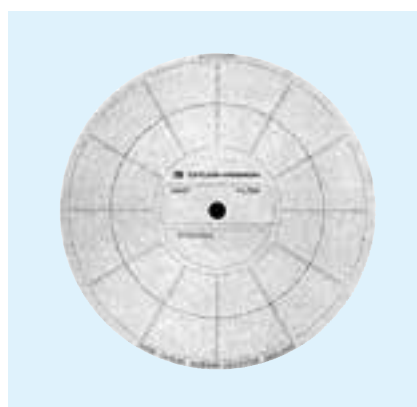

Materials Comparison Chart

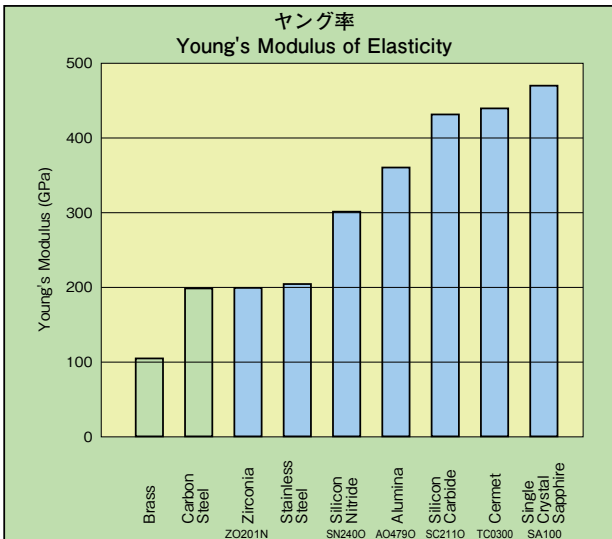
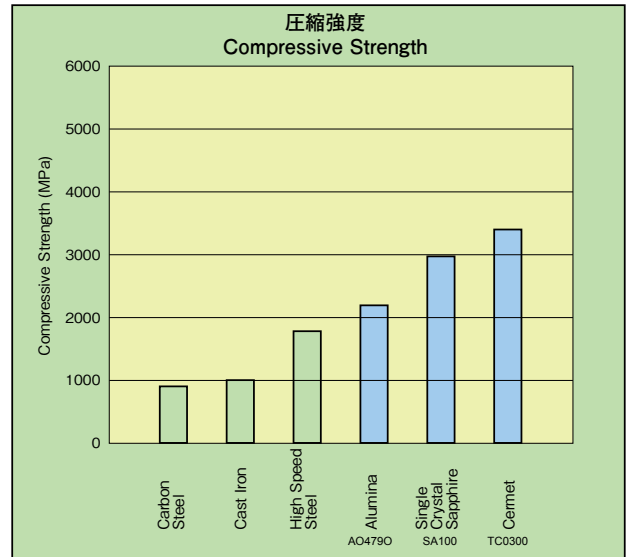
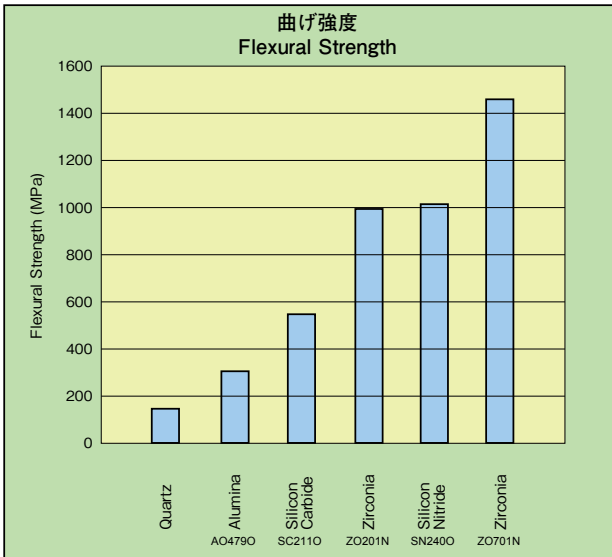
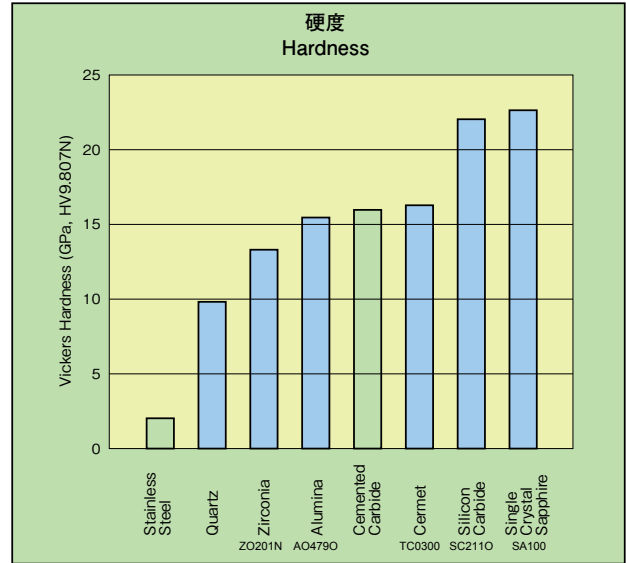
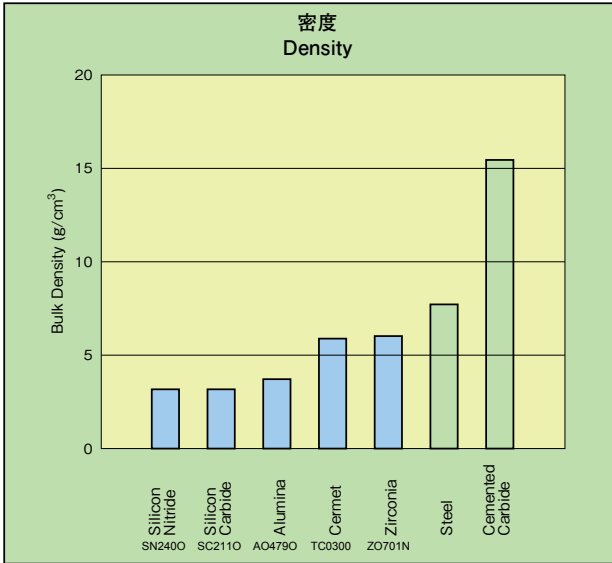

Materials Comparison Chart

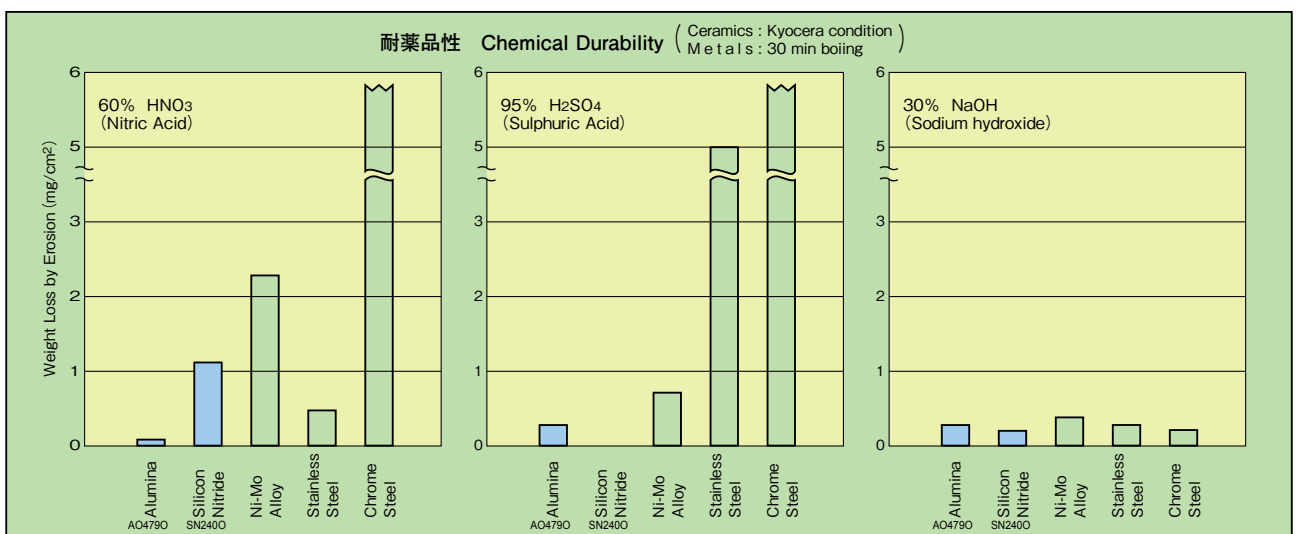
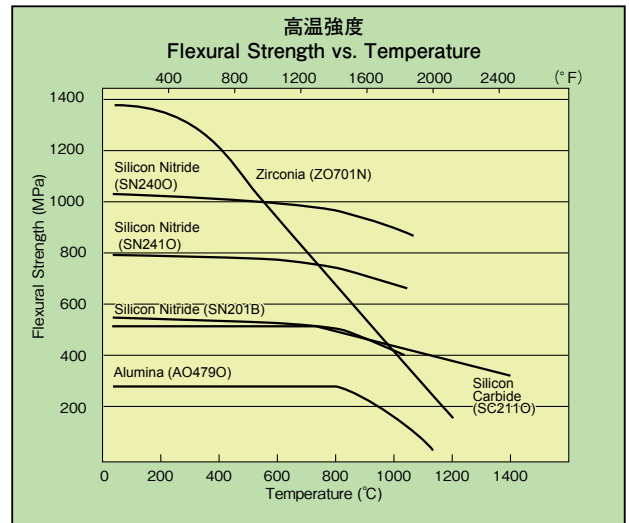
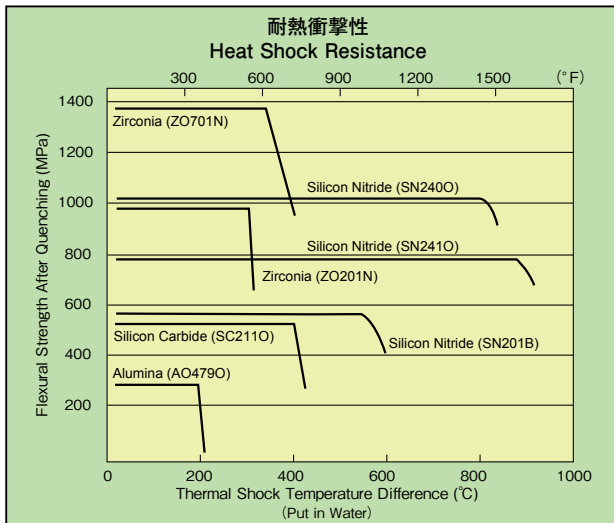
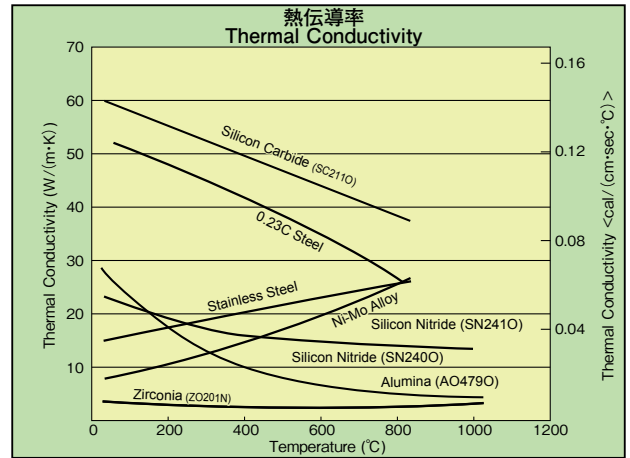
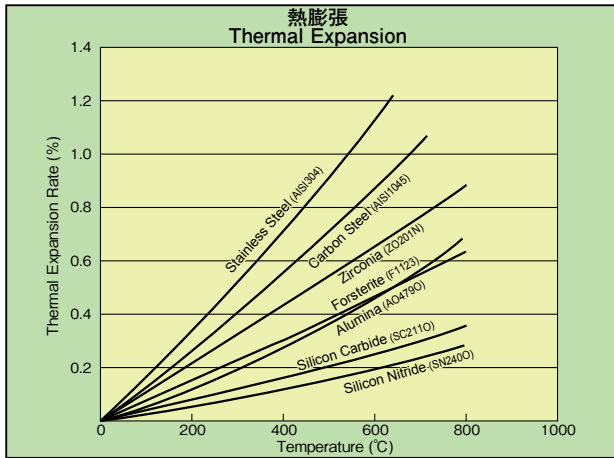

換算表 (Unit Conversion Table)

■ 応力 (Stress)		
MPa or N/mm ²	kgf/mm ²	psi (=lbf/in ²)
1	1.020 × 10 ⁻¹	1.450 × 10 ²
9.807	1	1.422 × 10 ³
6.895 × 10 ⁻³	7.031 × 10 ⁻⁴	1

■ 熱伝導率 (Thermal Conductivity)

W/(m · k)	kcal/(m · h · °C)	cal/(cm · sec · °C)
1	8.600 × 10 ⁻¹	2.389 × 10 ⁻³
1.163	1	2.778 × 10 ⁻³
4.186 × 10 ²	3.600 × 10 ²	1

接合金属の特性表 (代表例)

Characteristics Of Material (Example)

			Fe-Ni-Co Alloy	Alloy42	Ni	Mo	Al	OFHC (COPPER)	STEEL	SUS304	SUS316	Cu/W-10	Cu/W-15	Ti
Composition by Weight(%)			Fe54 Co17 Ni29	Fe58 Ni42	Ni99.0 min	Mo99.9	Al99.4	Cu99.96	Fe99.2	Fe67 Cr20 Ni10	Fe62 Cr18 Ni14	Cu10 W90	Cu15 W85	Ti99.1
Application			1/0pin Lead Frame Seal Ring	1/0pin Lead Frame Seal Ring	Lead Frame	Heat Sink	Connector	Heat Sink	Flange Sleeve	Flange Sleeve	Flange Sleeve	Heat Sink	Heat Sink	Flange Sleeve
Bulk Density			8.3	8.2	8.8	10.3	2.7	8.9	8.7	7.8	7.98	17.3	16.4	4.51
Hardness Rockwell-B			70-85	60-80	50-80	54-58	-	12-43	55	90	90	105	103	-
Mechanical Characteristics	Tensile Strength	Mpa Kpsi	490-510 71-74	471 64	343-549 50-80	686-980 100-142	167-382 24-55	206 30	392 57	588 84	588 84	490 71	529 77	- -
	Elongation	%	Brazed 35	Brazed 35	Brazed 35	5	40	40	35	60	60	-	-	-
	Young's Modulus of Elasticity	Gpa Mpsi	137 20.0	147 21.4	200 29.0	324 47.1	69 10.0	117 17.0	196 28.4	193 28.1	193 28.1	333 48.5	314 45.7	106 -
Thermal Characteristics	Coefficient Of Linear Thermal Expansion	$\times 10^{-6}/^{\circ}\text{C}$ 20-500°C	5.7-6.2	7.5-8.5	15	5.7	23 (20-100°C)	18.3	13.9	18.7	16.0	6.0	6.5	8.4
	Thermal Conductivity	$\frac{\text{W}}{\text{M}\cdot\text{K}}$ 20°C 100°C	16.7 18.4	14.7 16.7	84.1 82.9	155 147	151 -	391 393	58.6 -	- 16.3	- 16.3	170 -	190 -	- 17.2
	Specific Heat	Cal/g°C	0.105	0.120	0.130	0.060	0.210	0.090	-	0.120	0.120	0.05	0.07	0.124
Electrical Characteristics	Volume Resistivity	$\mu\Omega\cdot\text{cm}$ 20°C	48	58	6.8	5.8	2.7	1.7	12	72	74	-	-	55
	Electrical Conductivity	%IACS	-	-	-	-	64	100	18	2.4	-	26	34	3.1

※これらの値は参考値です。特性値は製品の形状や使用条件により異なる場合があります。

※The values are typical material properties and may vary according to products configuration and manufacturing process.

メタライズ技術、各種素材と加工 Metallization Technologies And Materials

Mo-Mn メタライズ法 Mo-Mn METALLIZATION

アルミナ ALUMINA (Al ₂ O ₃)
サファイア SAPPHIRE (Al ₂ O ₃)

活性金属法 ACTIVE METAL BONDING

アルミナ ALUMINA (Al ₂ O ₃)
サファイア SAPPHIRE (Al ₂ O ₃)
窒化ケイ素 SILICON NITRIDE (Si ₃ N ₄)
窒化アルミ ALUMINUM NITRIDE (AlN)

接合金属 BONDING METALS

MAGNETIC METALS (磁性)	NON-MAGNETIC METALS (非磁性)
29% Ni17% CoFeAlloy Ni	Titanium Gold(Au)
42% NiFeAlloy 430Stn.Stl.	Tantalum Silver(Ag)
52% NiFeAlloy Monel*	Inconel Copper(Cu)
	Niobium 70% Cupro Nickel
	Tungsten Aluminum(Al)
	Molybdenum Aluminum Alloy
	304Stn.Stl.

* Monel and Inconel are registered trademarks of the International Nickel Co.,Inc.

ろう材 BRAZING MATERIALS

ろう材 Brazing Material	融点 Melting Temp.(°C)	成分 Composition
Silver Copper	780	72%Ag-28%Cu
Gold Copper	990	37%Au-63%Cu
Gold Nickel	950	82%Au-18%Ni
Aluminum Alloy	580	Al-Si-Mg
Gold	1064	99.9%Au
Silver	961	99.9%Ag
Copper	1084	99.9%Cu

室温における各種真空用材料のガス放出速度 COMPARISON OUTGAS SPEED OF VARIOUS MATERIAL

真空用材料 Material	室温におけるガス放出速度 OUTGAS SPEED at RT[Torr·l/cm ² sec]	
	After Vacuum at RT	24hrs after Baking(°C)
セラミックス CERAMIC	10 ⁻⁹ ~10 ⁻⁸	10 ⁻¹⁵ ~10 ⁻¹⁴ (400)
ナイロン NYLON	2×10 ⁻⁸ (51hrs after Vacuum)	4×10 ⁻¹¹ (120)
フッ素ゴム FKM	7×10 ⁻⁸ (51hrs after Vacuum)	1.3×10 ⁻⁹ (200)
フッ素樹脂 PTFE	10 ⁻⁸ ~10 ⁻⁷	小さい(Less) (250)
ガラス GLASS	10 ⁻⁹ ~10 ⁻⁸	10 ⁻¹⁵ ~10 ⁻¹⁴ (400)
金属 METAL	10 ⁻⁹ ~10 ⁻⁸ (50hrs after Vacuum)	10 ⁻¹⁵ ~10 ⁻¹⁴ (400)

セラミックスと金属の基本的な接合構造

Basic Design of Ceramic-To-Metal Bonding

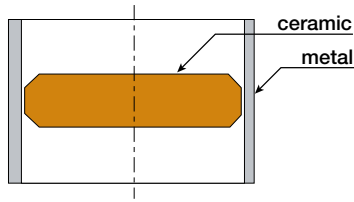

(1) アウトサイドシール
Outside seal

セラミックスに金属による圧縮応力がかかるため信頼性の高い構造です。
Highly reliable construction because compression stress from the metal is applied to the ceramics.

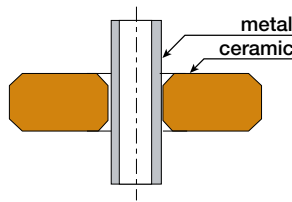

(2) インサイドシール
Inside seal

内側の金属の熱膨張係数に注意する必要があります。セラミックスより大きい場合、セラミックスが割れることがあります。
It is necessary to pay attention to the coefficient of thermal expansion of the metal. It may be cracked if the coefficient of thermal expansion of the metal is higher than that of the ceramics.

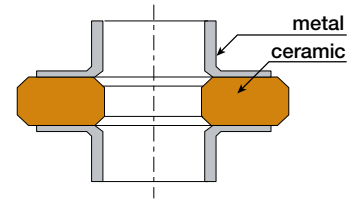

(3) バットシール
Butt seal

組立が容易な構造
Easy-to-assemble construction.

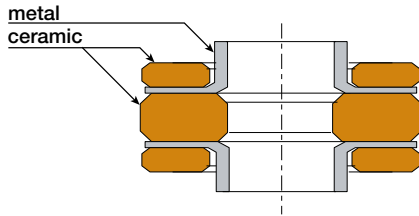

(4) バックアップリング付バットシール
Butt seal with back-up ring

組立が容易な構造で応力を分散させるためにバックアップリングを用いています。
Easy-to-assemble construction. A back-up ring is used to distribute the stress.

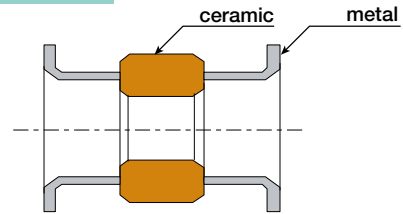

(5) エッジシール
Edge seal

接合面の平面度が必要な構造です。平面度が悪いと信頼性が低下します。
Flatness is needed to bond the surfaces. If the flatness is not good, the reliability will be poor.



KYOCERA Corporation

Corporate Fine Ceramics Group

J P: <https://www.kyocera.co.jp/prdct/fc/>

Product Inquiries→



EN: <https://global.kyocera.com/prdct/fc/>

Product Inquiries→



The contents of this catalog are subject to change without prior notice for future improvement.
Application and the using conditions are required to be consulted when considering to purchase.

Duplication or reproduction of any part of this brochure without approval is prohibited.

© 2023 KYOCERA Corporation 037/010/2302 Printed in Japan